

IBM Customer Engineering Reference Manual

7608 Power Converter

7618 Power Control

IBM

7608 Power Converter

7618 Power Control



Mr John V Gardner
2950 Stonecreek Rd SE
Smyrna GA 30080-3320

Preface

This manual is a minor revision of the 7608/7618 sections of the Customer Engineering Reference Manual, *IBM 7090 Data Processing System*, Form 223-6864-1, now obsolete. A companion document is the Customer Engineering Manual of Instruction, *IBM 7090 Power Supply Control and Distribution*, Form 223-6904.

Address comments regarding this publication to:
IBM Corporation
Customer Engineering Manuals, Dept. 296
P.O. Box 390
Poughkeepsie, N. Y.

Contents

1. Scheduled Maintenance	5
1.1 Introduction	5
1.2 Scheduled Maintenance Procedures	5
2. Diagnosis	7
2.1 Troubleshooting	7
2.2 Performance Tests	7
2.3 Power Sequencing	8
3. Servicing Procedures	9
3.1 Power Control Unit	9
3.1.1 Power Control Panel	9
3.1.2 Generator Exciter-Regulator Control Panel	10
3.1.3 48 Volt Power Supply	11
3.1.4 Motor Driven Variable Autotransformers	13
3.1.5 Circuit Breakers and Fuses	15
3.1.6 Relays, Timers, Contactors, and Starter	18
3.1.7 Resistors and Rectifiers	22
3.1.8 Connectors and Exterior Cables	23
3.2 Power Converter	24
3.2.1 Motor	24
3.2.2 Generator	25
3.2.3 Ventilating System	25
3.2.4 Reset Switch	26
3.2.5 Connectors	26
4. Machine Locations	29
4.1 Power Control	29
4.2 Power Converter	31
5. Service Aids	33
5.1 Power Connections in the 7090 System	33
5.2 Measurements	33
5.2.1 Generator Frequency	33
5.2.2 Voltage and Current per Phase	33
5.2.3 Amplitude Modulation	33
5.2.4 Power Factor	33

Safety

Lethal voltages are plentiful in the 7090 power system. Do not work on the power converter or power control unless power is turned off. In some portions of the power control, lines remain live even with power turned off at the machine. For example, нн29, св30, and fuse 1 are in a sealed box because they are unsafe to work on until power is shut off at the wall switch.

Beware of rotating machinery when removing covers from the power converter.

1 Scheduled Maintenance

1.1 Introduction

Scheduled maintenance is cleaning, lubrication of moving parts, and observation (to check for wear, rust, loose screws, and so on).

Do not unnecessarily adjust or disassemble properly operating units. Adjustments may be necessary when new parts are being broken in but, when the parts have been in place for some time, wear against each other results in perfectly mated surfaces. When this stage is reached, further wear is at a minimum because the parts are polished and offer little friction to each other. If adjustments are made at this point, the wearing-in process must be repeated, and the life of these parts is shortened because of wear.

If the machine is operating correctly, adjusting parts to bring them within specified tolerances cannot make it operate better but may make it worse.

1.2 Scheduled Maintenance Procedures

A punched card from the local customer engineering office will be sent to your installation when scheduled maintenance is due on a machine unit. When you receive this card, open the IBM Customer Engineering Reference Manual to the inspection routine chart. This chart has information on the routine scheduled maintenance to be done. Scheduled maintenance usually may be performed by referring only to this chart; in some cases, such as a routine check of waveforms, it is also necessary to refer to the manual page listed in the chart.

If the machine continues to operate satisfactorily after scheduled maintenance and nothing unusual turns up, sign the card, and send it back. If something out of the ordinary is found, particularly with mechanical units, refer to the page noted in the chart for more detailed information about how to check, adjust, and/or remove the troublesome item.

SCHEDULED MAINTENANCE ROUTINE					
Code	Unit or Routine	Freq	Operation		Page
8	POWER SUPPLY	26	7618	Check 48-volt supply. Measure 48 ± 4.8 volts across fuse 1	11
7	RELAYS	52		Check relays and contactors. Look for burned points, binding, air gap, and rise	18 20
9	ROUTINE 9			Check for loose terminal connections and charred insulation	
9	ROUTINE 9	13	7608	Check generator brushes for wear	25
		52		Clean base. Lubricate bearings. Check for loose terminal connections and charred insulation. Note: The 52-week schedule for bearing lubrication is based on 3-shift operation.	25

2 Diagnosis

2.1 Troubleshooting

Trouble in the power converter and control system will usually show up as:

1. Lack of output voltage because of power shutdown
2. High or low output voltage
3. Incorrect output frequency

See Figure 2.1-1 which is a troubleshooting guide.

2.2 Performance Tests

Power is usually turned on for the system as follows:

1. Turn on main wall switch
2. Depress power-on-reset switch
3. Reset MG-CB-1 on the front of the 7608 power converter

4. Depress the power-on switch, either on the 7618 power control or the 7151 console

Steps 1, 2, and 3 are necessary only for an initial power-on or after using the emergency off switch.

The following circuit breaker points must be closed to complete a normal power-on sequence (the physical location of these components may be found on Systems 9.08.02.0 or in Section 4):

CB30 supplies the 60 cycle control circuits and must be closed to energize the power-on-reset switch. It is on the front of the 7618 power control.

CB32 supplies 60 cycle power to the cooling blower motor in the 7608 power converter; it must be closed to start the motor generator. It is on the front of the 7618 power control.

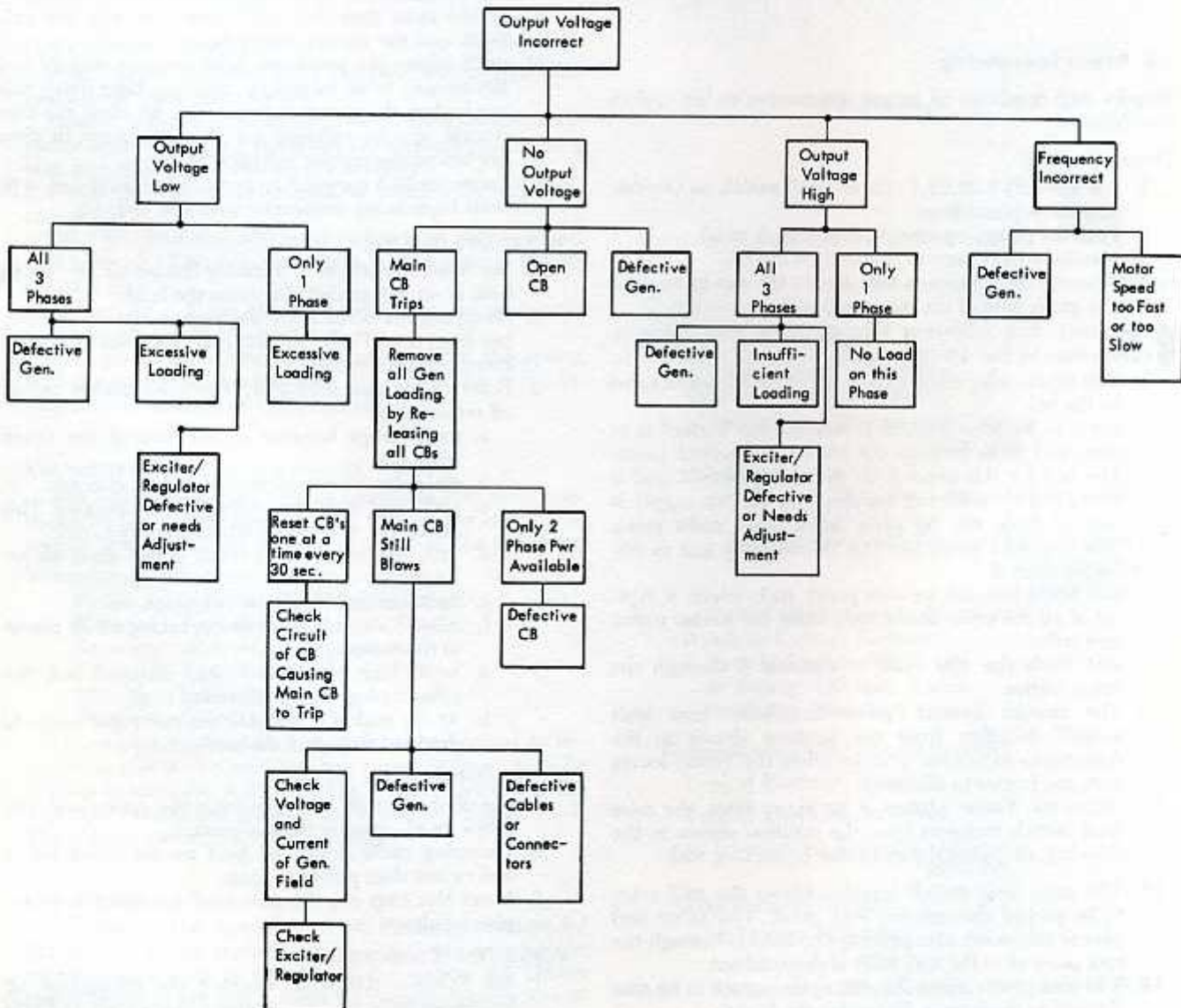

Figure 2.1-1. Troubleshooting Guide

HR30 is operated by a key on front of the enclosure to reset the thermal overload devices that protect the large motor. It requires resetting only after a motor overload. It is on the front of the 7618 power control.

MG-CB1 is a protective unit in the output of the alternator and must be reset (after pushing power-on-reset) when initially bringing up power, or after an emergency off. It is located on the front of the 7608 power converter.

CB28, CB29, and CB31 are in the 400 cycle lines that supply the frames. They must be on to make power-on switches operable. They are located on the front of the 7618 power control.

CB1 to CB13 protect the cable wires associated with individual frame blowers. The CB for a particular frame must be on to allow 400 cycle power to be supplied to that frame. They are on the power control panel of the 7618 power control.

CB33 supplies 60 cycle power to the core storage heater-pump unit and must be on to bring up power on the core storage. It is on the front of the 7618 power control.

2.3 Power Sequencing

Step-by-step operation of power sequencing in the system is as follows:

POWER ON

1. See Systems 9.02.01.1. Throw wall switch on to energize three-phase lines.
 2. Push the power-on-reset button to pick HR29.
 3. Manually reset MG-CB1, located on the MG.
 4. Pressing the power-on key causes the MG to start. It also picks both of the DC-on relays.
- CAUTION:** Not following this sequence may cause a blown fuse in the 48-volt supply.
5. The DC-on relay causes the pick of HR30. HR30 turns on the MG.
 6. Refer to Systems 9.02.02.1. Assume the Variac* is at zero. HR1 picks through the 400 cycle interlock point. The coil for this point is on Systems 9.02.06.1 and is energized by a 48 volt supply. The 48 volt supply is derived from the 60 cycle input after HR29 picks. This interlock point ties the DC-on relay bus to 60-cycles neutral.
 7. HR1 holds through its own point. HR1, which is typical of all the other contactors, starts the Variac motor upwards.
 8. HR1 feeds the 400 cycle to channel 1 through the rising Variac.
 9. The contact named "power-on Variac zero limit switch" transfers from the position shown in the drawing to its normal position when the Variac leaves zero and begins to move up.
 10. When the Variac arrives at its upper limit, the raise limit switch transfers from the position shown in the drawing, dropping the HR1 relay by picking HR2.
 11. The raise limit switch transfer allows the HR2 relay to be picked through the HR1 point. The M/CI and blower relays are also picked. The hold is through the HR2 point after the HR1 relay is dropped out.
 12. The HR2 points allow the 400 cycle supply to be sent directly to the frames, bypassing the Variac.

* Trademark of General Radio Company

13. The Variac is driven downward when HR1 drops out. When it reaches its lowest point, the zero limit switch transfers to the position shown in the drawing.
14. Systems 9.02.03.1 and 9.02.04.1 are similar to 9.02.02.1 except for differences in the arrangement of the switches and lights of CPU2 and the console.
15. Refer to Systems 9.02.05.1. DR15 is picked at the same time as HR1. The core storage standard supply is brought up in the same way as any standard supply, except that DR15 is used as a return. DR15 is also used to pick the core storage blower relay and HR38 on 9.02.06.1.
16. HR25 operates as did HR1, and HR26 as HR2. But when HR26 is picked so is DR14, giving a return for HR27.
17. When the zero limit switch returns to the position shown (see step 13), HR27 picks. Now HR27 and HR28 operate as did HR1 and HR2, driving the Variac up and down again for a second time.
18. The Variac is brought up for a second time to allow the core storage special voltages (+30, +60 volts) to come up later than regular voltages. The Variac is connected only to these supplies for its second trip.
19. At the same time that HR28 picks, we also get TD1, DR32, and the system reset relay.
20. DR32 allows the power-on light for core storage and the console to be turned on. TD1 is a time delay unit used when the power is turned off, to allow the core storage special voltages (+30, +60 volts) to drop out before the regular voltages do.
21. Points HR26-4 are used to prevent the +30 and +60 volts from being sequenced with low voltages.

POWER OFF (DC OFF)

1. See Systems 9.02.01.1. Pushing the DC-off key drops both DC-on relays and also drops the hold.
2. Dropping the DC-on relay disconnects the DC-on relay bus from the 60 volt neutral. This drops out all frames except for core storage.
3. Refer to Systems 9.02.05.1. The core storage power off sequence is:
 - a. DR15 drops because of the loss of the DC-on relay bus.
 - b. DR14 drops because the DR15 point opened.
 - c. HR28 and DR32 drop because DR14 opened. This allows the +30 and +60 volt supply to fall.
 - d. TD1, because of its built-in delay, stays on for 5 seconds.
 - e. HR26 holds through the TD1 point.
 - f. After 5 seconds HR26 drops, taking off all power to the memory frame.
 - g. HR38 stays on. When DR15 dropped out, the other timing unit, TD2, started to go.
 - h. At the end of 3 minutes the TD2 point opens to drop out HR38 and the blower relay.

POWER OFF (NORMAL OFF)

1. See Systems 9.02.01.1. Pushing the normal-off key drops HR30, opening the MG contacts.
2. Dropping HR30 drops the hold on the DC-on relays and causes their points to open.
3. From this step on, the power-off sequence is as explained above.

POWER OFF (EMERGENCY OFF)

1. See Systems 9.02.01.1. Pushing the emergency off key drops HR29 to open all three-phase lines and kills everything, including the convenience outlets.

3 Servicing Procedures

3.1 Power Control

The IBM 7618 Power Control unit houses the motor-generator controls, power sequencing and marginal check motor driven autotransformers, and the power distribution system.

3.1.1 Power Control Panel

The following parts are mounted on the power control panel of the power control unit:

1. Power on-off switches
2. Voltmeter and range selector switch
3. Circuit breakers for the blowers in each unit of the system
4. Circuit breakers for the convenience outlets in each unit of the system

POWER ON-OFF SWITCHES

Power on-off switches are of the push button type. The functions of these switches are:

Power On Reset – Makes 60 cycle power available in the power control unit (PC); energizes the memory heater-pump unit; energizes the 48 volt supply in the PC.

Power On – Starts the MG and/or initiates the DC power-on sequence.

DC Off – Removes 400 cycle power from each unit and thus turns off all DC voltages in each unit of system. The MG set stays on.

Normal Off – Turns off all DC voltages in the same manner as DC off, but also stops the MG set.

Emergency Off – Removes all power from the system with the exception of a few lines in a sealed box in the PC. This sealed box encloses CB30 and HR29.

VOLTMETER AND SELECTOR SWITCH

The voltmeter on the control panel has two ranges selected by the selector switch at the right of the meter. The voltmeter measures the 400 cycle output of the generator.

Voltmeter specifications are:

Range	116-124, 200-216 volts AC
Type	Peak sensing
Accuracy	.25% at room temperature .5% from 0°C to +40°C
Mounting	Vertical
Frequency	375-425 cps

To read the high range, voltage must be applied to terminals A and B. To read the low range, voltage must be applied to terminals A and C while D and E are connected together. Terminal G grounds the meter. See Figure 3.1-1. The selector switch is wired as shown.

CIRCUIT BREAKERS

Mounted on the control panel are 13 circuit breakers for the blowers in the system and 14 circuit breakers for the convenience outlets in all units of the system. All blower circuit breakers are alike except the memory blower circuit breaker which is rated for a higher current. All circuit

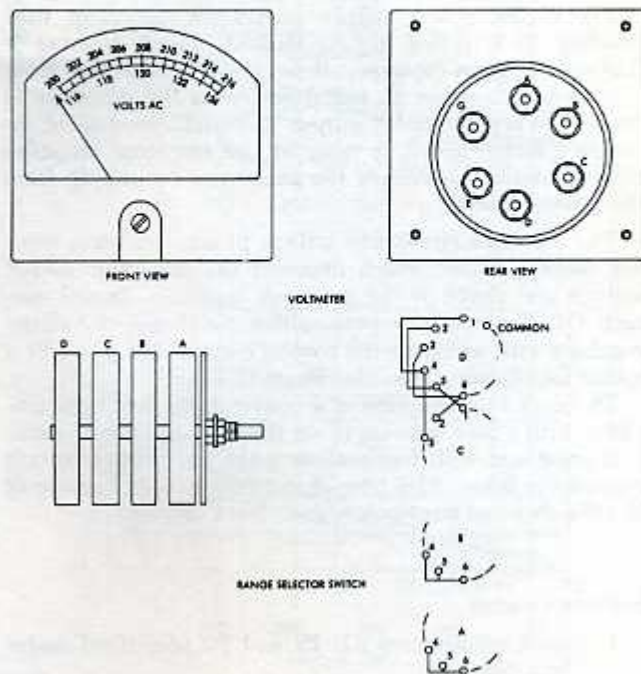

Figure 3.1-1. Voltmeter and Selector Switch

breakers for the convenience outlets are alike. See Figure 3.1-2 and the following table:

Blower Circuit Breakers

Type of Element: Magnetic
Type of Trip Circuit: Series
AC Interrupting Capacity: 250 volts
1000 amp

Trip Element Ratings

AC Rating: 250 volts, 1 amp (8 amp for memory blower)
Resistance at Rated Current: $1.0 \pm .2$ ohms ($0.2 \pm .004$ ohms for memory blower)

Operating Frequency: 60 cycles

Auxiliary Contact Ratings:

Type of Circuit: SPDT
AC Rating: 125 volts, 5 amp
DC Rating: 50 volts, 1 amp

Convenience Outlet Circuit Breakers

Type of Element: Magnetic
Type of Trip Circuit: Series
AC Interrupting Capacity 125 volts
2000 amp

Trip Element Ratings

AC Rating: 120 volts
15 amp
Resistance at Rated Current: $.007 \pm .0014$ ohm
Operating Frequency: 60 cycles

3.1.2 Generator Exciter-Regulator Control Panel

The exciter-regulator has two basic circuits, an exciter power supply to energize the generator field initially, and a regulator circuit for voltage regulation and removal of transient voltages from the output. See Figure 3.1-3.

The exciter power supply excites the generator field winding. It is called a field flashing circuit because it flashes (energizes for a short time) the generator field from a DC source to cause an initial output as the generator is rotated. When generator output increases, because of increasing motor speed, a relay in the magnetic amplifier control circuit disconnects the exciter power supply from the generator field.

The regulator circuit has a three phase, full wave rectifier sensing circuit which monitors the generator output voltage and develops the magnetic amplifier control current. Q1, the transistor preamplifier stabilized by voltage regulator VR1, amplifies the control current and provides a means for adjusting gain. See Figure 3.1-4.

The magnetic amplifier is a conventional feedback amplifier with a bias winding to set the control current operation point and with feedback to make the control current curve more linear. This type of amplifier is used because of its reliability and large power gain. See Figure 3.1-5.

SERVICE CHECKS

1. Check adjustments P1, P2 and P3 (described under "Adjustments").
2. Check that CR1 relay points open when the generator voltage builds up to about 200 volts.
3. Measure the magnetic amplifier bias current with a volt-ohmmeter; 13 ma DC should be flowing in bias winding (F6 and F10).
4. Check the magnetic amplifier output waveform at the generator field winding terminals. See Figure 3.1-6.
5. Measure the voltage drop across VR1 when it is ignited. This voltage should be 97V DC.
6. Measure the field flashing power supply terminal voltage with CR1 de-energized. It should be 8.75 volts.
7. Check diodes (D1-D6) in the three phase, full-wave rectifier line voltage sensing circuit. It is difficult to measure accurately their forward and back resistance with a standard volt-ohmmeter (VOM). Therefore, if a standard VOM gives a ratio of at least 1000 to 1 between forward and back resistance, consider the diodes normal.
8. Check the magnetic amplifier load winding diodes (D8-D11 and D14-D17) with a VOM as explained above.

INSPECTION

Inspect all terminal boards for loose screws and wires. Inspect the potentiometers for burned windings or cracked carbon wiper brushes. Inspect for loose hardware, leaking capacitors, frayed cables and broken wires.

ADJUSTMENTS

1. Exciter-Regulator Controls (Potentiometer P1). To compensate for load variations, adjust for correct terminal voltage at the generator output (208 volts as measured on the panel meter).
2. Bias (Potentiometer P2). Adjust to produce 13 ma DC through the bias winding (F10 and F6).

3. Stability Adjustment (Potentiometer P3). With no load on the generator, rotate the positive feedback potentiometer (P1) suddenly through 50% of its total range. Observe the generator output voltage envelope on an oscilloscope. The stability potentiometer (P3) should be adjusted to produce three swings or less of the generator output voltage.

If the field flashing power supply fails to provide enough voltage, substitute a DC power source (such as a battery). Place it across the field terminals F1 and F2 for a very short time. Observe correct polarity: negative terminal on F1, positive terminal on F2. When the generator is producing enough output, remove the DC source and check the power supply.

TROUBLE ISOLATION

When there is a loss of output from the motor generator, trouble may be isolated to the MG set or to the generator exciter-regulator control circuits by the following information and procedures.

Three basic circuits are involved:

1. Exciter power supply to energize the generator field initially. This supply (T3) is dropped by the CR1 points when the generator output picks the CR1 relay.
2. Regulator circuits for voltage regulation and removal of transients from the output. The regulator circuit contains a 3-phase, full-wave rectifier sensing circuit that monitors the generator output voltage and develops the magnetic amplifier control current (sx1).
3. Generator field circuit in the MG set.

The following procedure may isolate the trouble to either the MG set or the 7618 control circuits:

1. With the system emergency off switch tripped and all wall circuit breakers tripped, disconnect field terminals F1 and F2 at TBL in the 7618 (Systems 09.09.01.1).
2. Check across F1 and F2 for continuity in the generator field winding, which should measure about 6-8 ohms.
3. If this resistance is within limits, "flash" the generator field by using the 60-cycle, 48-volt DC portion of the 48-volt supply. Be sure that the positive side of 48 volts is applied to F2.
4. Reset the wall circuit breakers and the emergency off switch on the system.
5. Hit "power-on reset" at the PDR. The MG should now be turning over.
6. Apply 48 volts across F1 and F2 and check the voltage at L1, L2, and L3. Terminals for these points are located at TBL.

If the MG set is functioning correctly, the output at L1, L2, and L3 should be half the normal 208-volt output. The reason for this low output is that only 48 volts is being applied, whereas the normal field voltage is 97 volts. If there is no output at L1, L2, and L3, the trouble is in the MG set. If these MG set tests do not indicate failure, the trouble is in the 7618 generator exciter-regulator control circuits.

DANGER: Because this area of the machine contains dangerous voltages throughout, be extremely careful and observe all safety precautions.

REMOVAL AND REPLACEMENT

Unfasten all connecting wires, remove mounting screws and remove the defective component from the exciter-regulator chassis.

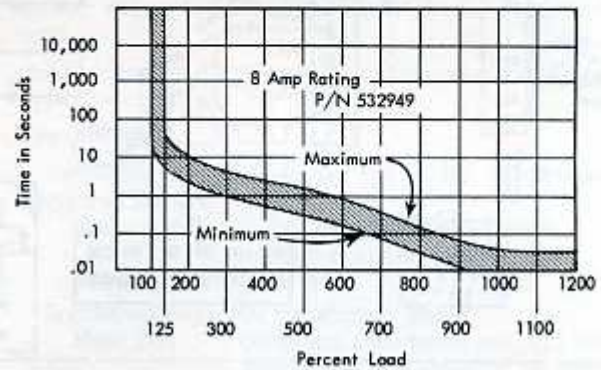
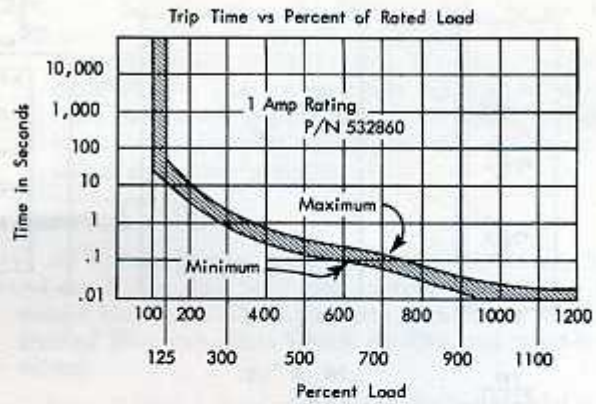
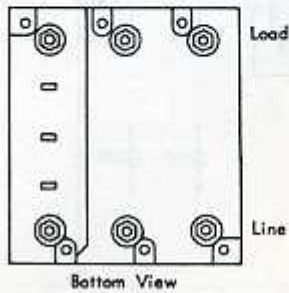
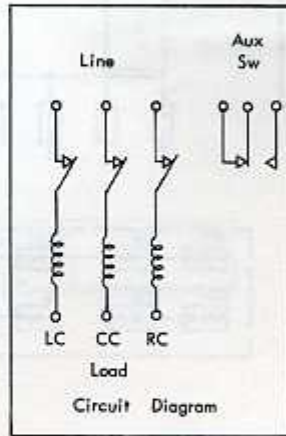
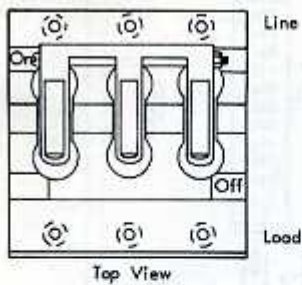

BLOWER CIRCUIT BREAKER

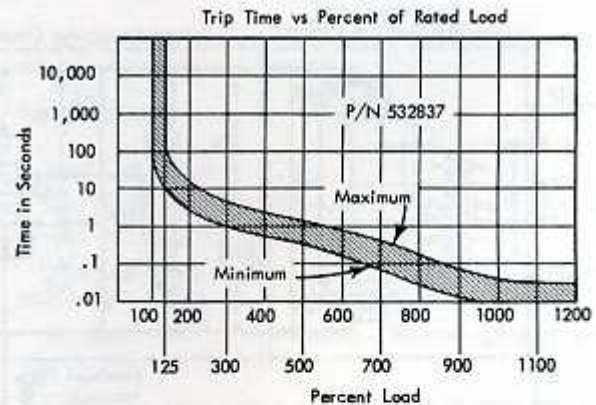
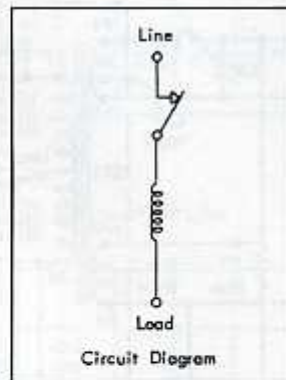
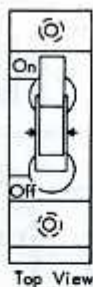

CONVENIENCE OUTLET CIRCUIT BREAKER

Figure 3.1-2. Control Panel Circuit Breakers

3.1.3 48 Volt Power Supply

Power to all power-on and power-check lights in the system is supplied by the 48-volt supply, which is also used with the open fuse, open thermal, and open air flow indication circuits.

This supply consists of a 60-cycle supply and a 400-cycle supply, operating in parallel. An output of 42 to 43 volts comes from the 60-cycle supply during the starting or stopping of the mc. Inadvertent tripping of cb1 in the individual power supplies in each sms frame is prevented. The 48-volt output of the 400-cycle supply prevents trip-

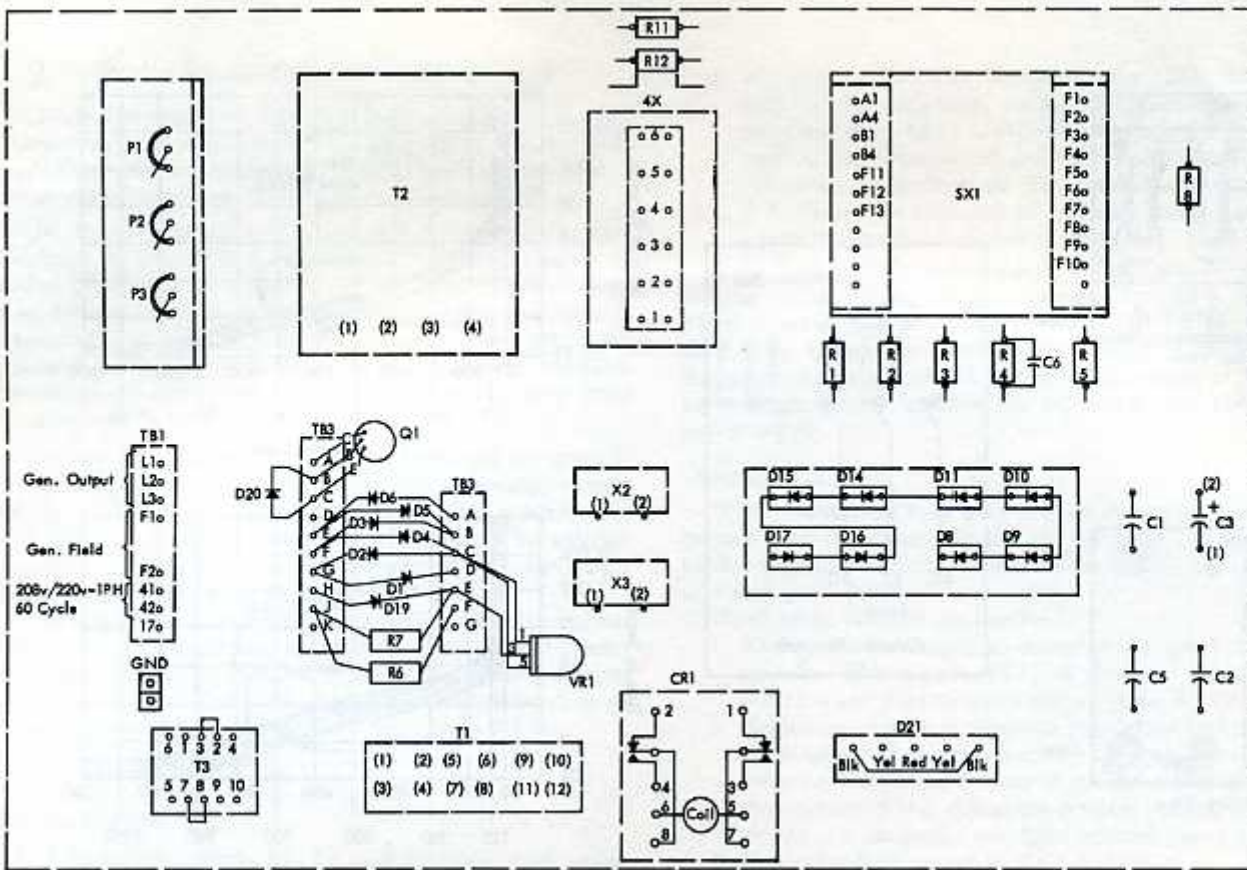

Figure 3.1-3. Generator Exciter-Regulator Panel

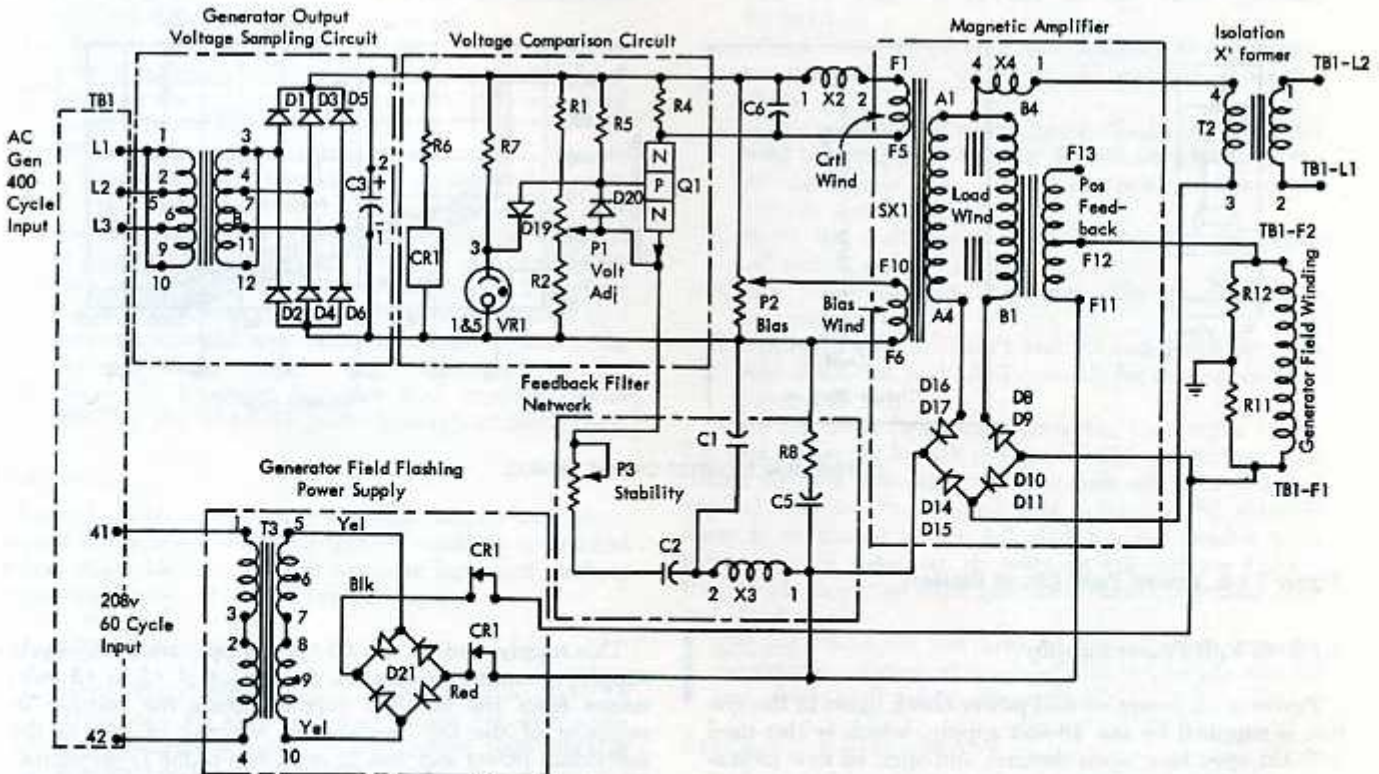

Figure 3.1-4. Generator Excitation and Regulation Schematic

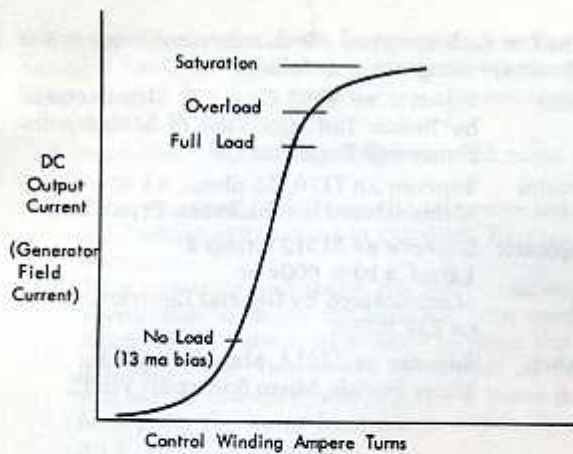
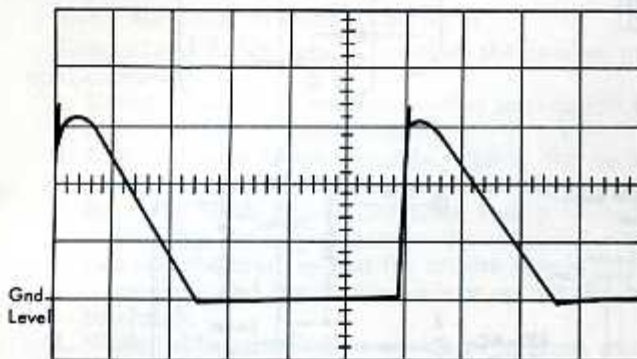
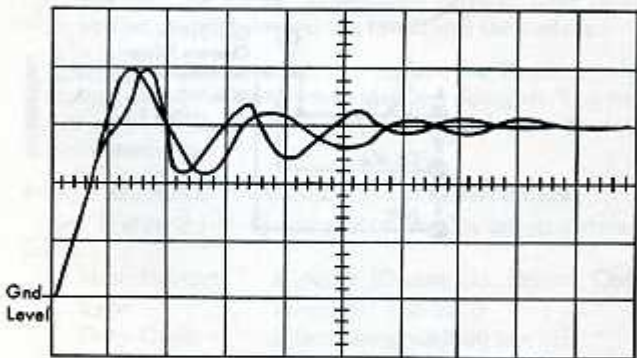

Figure 3.1-5. Magnetic Amplifier Characteristic Curve



Output of Mag-Amp @ F1 and F2

AC Fast 200 usec/cm
+ Internal 10 v/cm (10x Attenuation = 100 v/cm)



Output of Mag-Amp @ F1 and F2

AC Fast 2 usec/cm
+ Internal 10v/cm (10x Attenuation = 100 v/cm)

Figure 3.1-6. Magnetic Amplifier Output Waveforms

ping of the CB's when the 60-cycle input to the system fluctuates slightly. See Systems 9.06.11.1.

NOTE: Regularly check the CB in the primary of the 400-cycle supply. This CB may trip and cause low output from the 48-volt supply (42 to 43 volts), which may result in intermittent tripping of the CB's in the individual SMS power supplies.

SERVICE CHECKS

No Voltage Present. Check the fuses. Input fuses A2 and A3 are 1 amp slow blow type; output fuse A1 is a 3 amp instant blow type. Check for open transformer windings or shorted filter capacitor. Check rectifier and point-to-point wiring.

Low or High Voltage. Check for shorted bleeder resistor, shorted transformer windings or a defective rectifier. Secondary voltage on the transformer should be $36.5 \pm 3\%$ volts.

Excessive Ripple. Check the filter capacitor. Check for defective rectifier.

TRANSFORMER

Terminals mounted on the top of the transformer are labeled as follows:

Primary side 230v, 208v, 150v, LO (-10v),
NOMINAL, and HI (+10v)

Secondary side 36.5 volts

Specifications on this transformer are:

Heat Test 55°C rise (resistance method) with resistive load of 6 amperes on secondary tap

Insulation Test Primary to secondary: 1500v, 60 cycles
Secondary to core: 1000v, 60 cycles

Regulation 10% max. load as for heat test

Adjustments. Adjust the output voltage by moving the HI and LO taps on the primary.

SILICON RECTIFIER — See Section 3.1.7.

FILTER CAPACITOR

The electrolytic filter capacitor is rated at 2000 microfarads, 60 working volts.

Service Checks. Check visually for burned spots, leaking electrolyte and blown out expansion plugs.

Removal and Replacement. Observe proper polarity when replacing the leads.

CAUTION: Turn power off and wait at least one minute for charge to drain off before working on the capacitor. After one minute, you may short the capacitor with a screwdriver to make sure of complete discharge.

BLEEDER RESISTOR

The bleeder resistor is rated at 100 ohms, 45 watts.

Removal and Replacement. Be careful not to burn your fingers when replacing this part.

3.1.4 Motor Driven Variable Autotransformers

Three motor driven, variable autotransformers are in the power control unit. Two of these are used for the +6 volt and -12 volt marginal check; the third is used in the power sequence operation.

MARGINAL CHECK VARIABLE AUTOTRANSFORMERS
See Figure 3.1-7. Specifications on these autotransformers are:

Manufacturer	Superior Electric Co., Bristol, Conn.
Type	Powerstat 116-1085
Duty Cycle	100%
Max. E Input	240v AC, 3 phase, 400 cps
Max. E Output	240v AC, 3 phase
Max. I Output	7.5 amp
Motor—Nom. E Input	120v AC, single phase, 60 cps
Nom. Speed	2 rpm at Powerstat drive shaft or 30 sec. between 0 to 208 volt output

Attached to each marginal check autotransformer in the motor circuit are components as follows:

Motor	Superior BP 8592 Group 3, Manufactured by Brown Inst. Co. Div. of Minneapolis-Honeywell Regulator Co.
Resistor	Superior AR 7170, 24 ohms, $\pm 1\%$ Manufactured by Shallcross. Type 22 on
Capacitor	Superior BP 51313 Group 2 1.0 mf $\pm 10\%$ 600v DC Manufactured by General Electric Co., GE 22F 652M
Switch	Superior BP 51214, Manufactured by Micro Switch. Micro Sw. BZ 2R W822

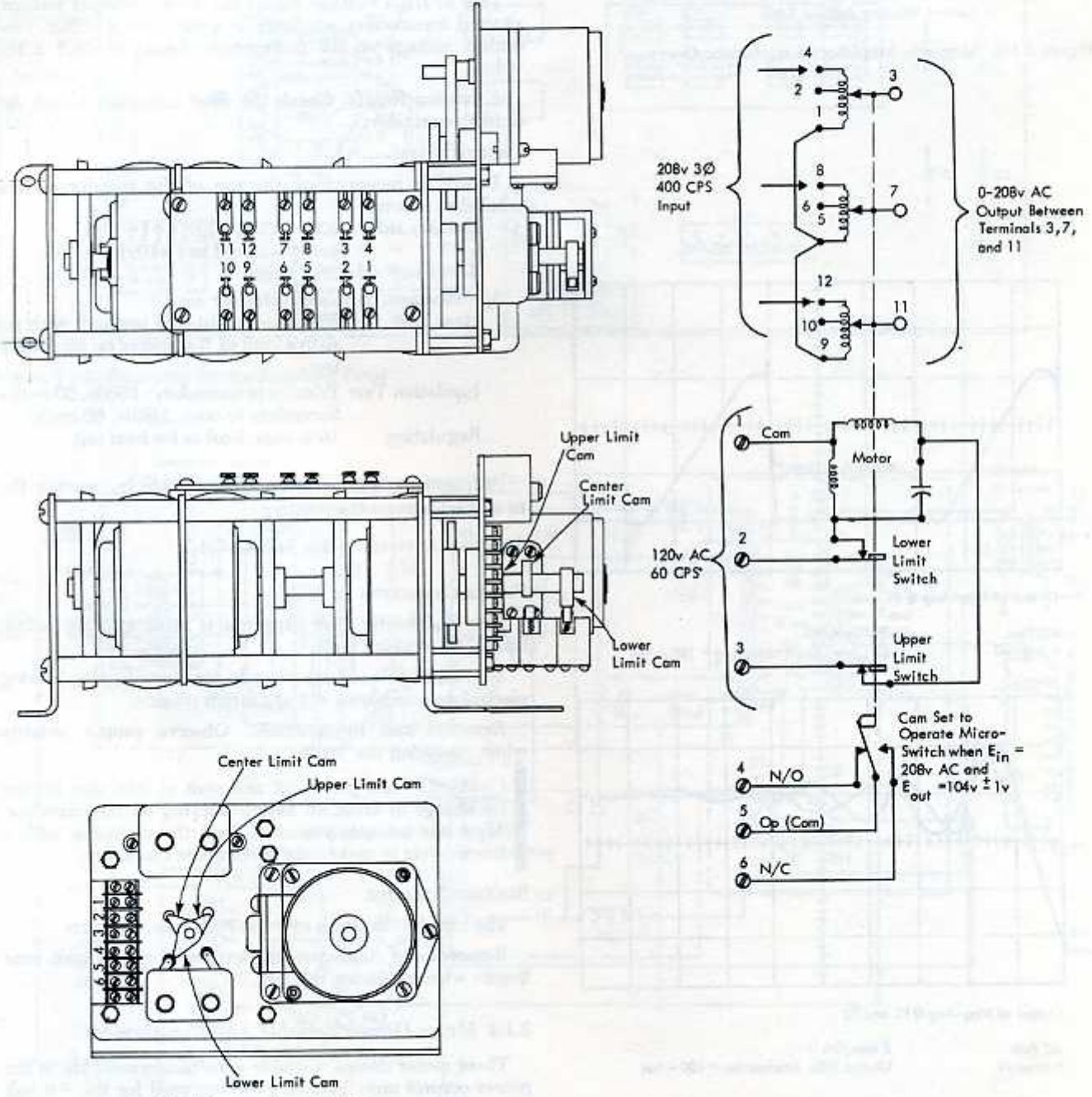

Top View (Shown at Lower Limit)

Figure 3.1-7. Variable Autotransformer for Marginal Checking

Service Checks. Check for arcing brushes; replace if necessary. Check for tight setscrews on the limiting switch cams. If no voltage is obtained from the autotransformer, inspect CB 35 to see if it has been tripped.

Adjustments. To adjust the limiting switch cams, proceed as follows:

1. Turn power off and loosen the setscrews holding the old limiting switch cams to the shaft. Replace cams if necessary.
2. Turn power on and rotate the autotransformer to its lowest limit. If the lowest limit has been reached, the motor will vibrate in its attempt to drive the brushes past their stop. Shut power off quickly so the motor will not be damaged, and adjust the lower limit cam to depress the lower limit micro switch. See Figure 3.1-7.
3. Turn power on again and bring the autotransformer to its upper limit. The motor will vibrate as in step 2. Shut power off and adjust the upper limit cam to depress the upper limit micro switch.

To adjust the autotransformer centering switch proceed as follows:

1. Observe the voltmeter on the console and rotate the autotransformer until the voltmeter is exactly on center position (+6 or -12v).
2. Shut power off and adjust the centering cam to depress the center micro switch.

NOTE: Make sure all setscrews are tight.

Removal and Replacement. To replace the brushes, proceed as follows:

1. Unfasten the brush assembly anchor screws, and remove and discard the old brush.
2. Insert the new brush assembly, replace the anchor screw or screws, and tighten the assembly in place.
3. Raise the brush slightly and place a strip of crocus cloth or fine sandpaper between the commutator surface and the brush so that the smooth side is on the commutator and the abrasive side is against the carbon brush.
4. While holding the cloth or sandpaper in place, rotate the knob through a short arc. Blow out excess carbon particles.
5. Remove the cloth or sandpaper and rotate the knob several times to check for smooth travel of the brush over the commutator surface. The brush should fit flat over the entire commutator surface; light should not be visible between the brush and the surface.

CAUTION: If it is necessary to replace the limiting switch cams, be sure to turn power off when doing so. The cams are close to the voltage terminal board on top of the autotransformer.

POWER SEQUENCING VARIABLE AUTOTRANSFORMERS

See Figure 3.1-8. Specifications on this autotransformer follow:

Manufacturer	Superior Electric Co., Bristol, Conn.
Type	Powerstat 136-1070
Duty Cycle	5 sec. runup with 60 sec. off
Max. E input	240v AC, 3 phase, 400 cps
Max. E output	240v AC, 3 phase
Max. I output	72 amps
Motor	
Nom. E input	120v AC, 1 phase, 60 cps
Nom. Speed	12 RPM at Powerstat drive shaft or 5 sec. between 0 to 208v output

The following components are connected to the power sequencing variable autotransformer in the motor circuit:

Motor	Superior ss150 with mounting plate (Supply with motor gear kit BP 56152)
Resistors	Superior BP 262 Group 13 250 ohms, 25 watt Mfd. by Ward Leonard, Resistor Inc., Ohmite Mfg.
Capacitor	Superior BP 16173 Group 2 3.3 mfd ±6%, 330v AC Mfd. by General Electric Co. GE49F1751
Switch	Superior BP 51214 Mfd. by Micro Switch Micro Sw. bz2RW822

Service Checks. Check for arcing brushes, and replace them if necessary. Check for proper motor and switch operation. Tighten setscrews on upper and lower limit switch cams. If no voltage can be obtained from the transformer, inspect CB34 to see if it has been tripped.

If it is impossible to drive the motor either up or down, check the condition of the micro switches. If the autotransformer will not return to zero, check continuity between contactors H1-4 to H1-24 (see Systems 9.02.02.1). Check fuse 4.

Adjustments. To adjust the limiting switch cams, proceed as follows:

1. Turn off power, then loosen setscrews on the cams. Replace the cams if necessary.
2. When the autotransformer is at its lowest limit (zero output voltage), shut power off, then adjust the lower limit cam to depress the lower limit micro switch. See Figure 3.1-8.
3. To adjust the upper limit switch, sequence power up on a unit such as the console. Do not use the memory unit. The autotransformer will travel to its upper limit and remain there. The motor will vibrate as it attempts to drive the brushes past their stop. Do not let this condition exist long, or the motor will be damaged.
4. Shut power off and adjust the upper limit cam to depress the upper limit switch.

NOTE: Be sure all setscrews are tight.

Removal and Replacement. Brush assemblies are replaced in the same way as for the M/C autotransformer.

3.1.5 Circuit Breakers and Fuses

The following types of circuit breakers are used in the power control unit. To locate these circuit breakers in Systems pages, see Systems reference diagram 9.08.07.0. For locations of these parts on the machine, see Section 4 of this manual.

CB	NAME	IBM P/N
1, 2, 4, 5, 6, 7, 8		
9, 10, 11, 12, 13	Blower CB	532860
3	Memory Blower CB	532949
14 to 27	Convenience Outlet CB	532837
28, 29	400 cycle, 208 volt line	532826
33	60 cycle, Mem Temp Ctrl	532826
30	60 cycle Input	519043
31	400 cycle M/C Output	517861
32	60 cycle M/C Blower	322489
34	400 cycle, Power Seq Powerstat	532845
35	400 cycle, M/C Powerstat	532920
M/C CB1	Under Voltage Control and Reset Switch	599052

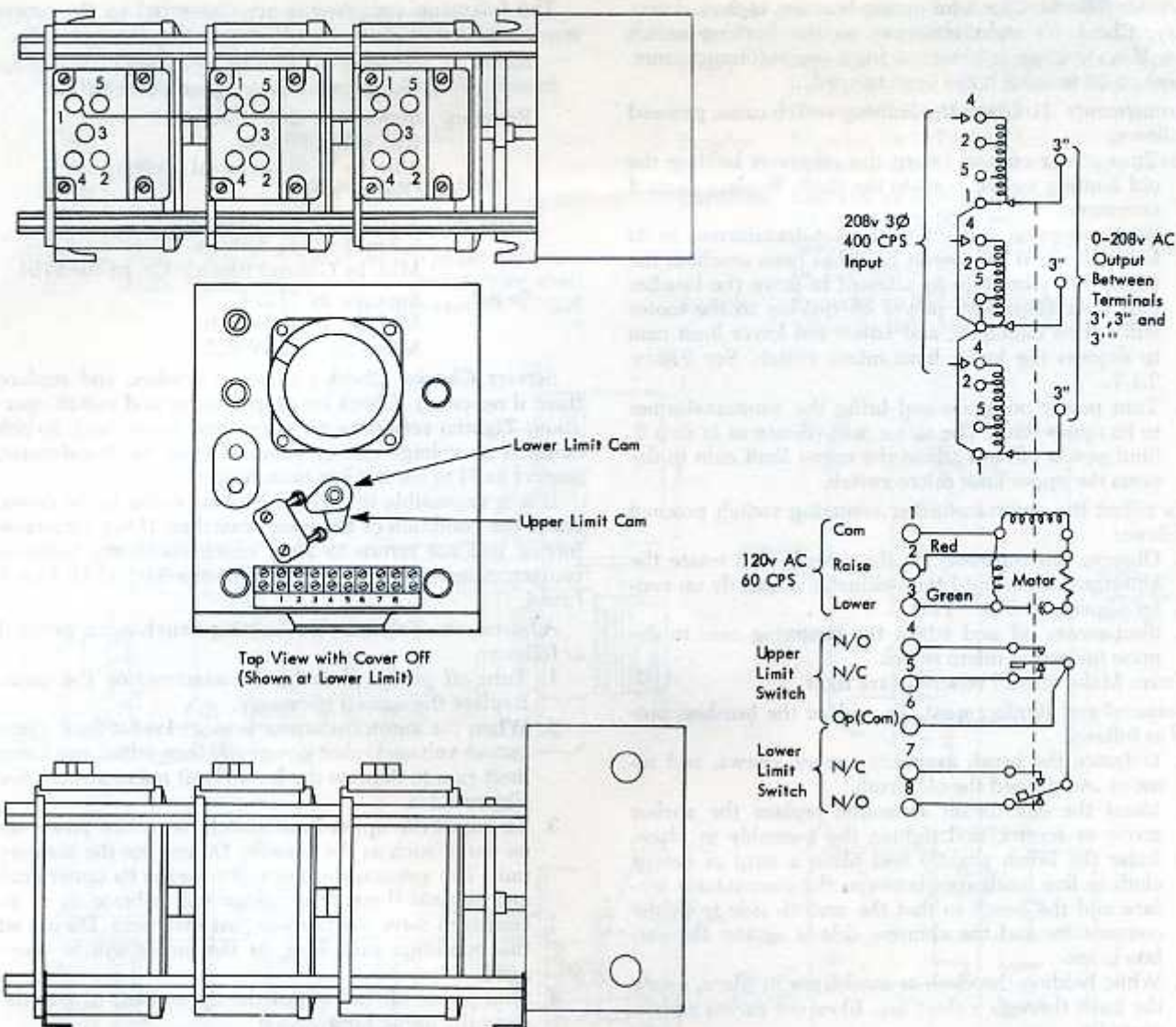

Figure 3.1-8. Variable Autotransformer for Power Sequencing

Blower and convenience outlet breakers are covered in detail in Section 3.1.1. The motor-generator breaker (MG CB1) is explained in Section 3.2.4. Other breakers and fuses will be discussed in following sections.

CIRCUIT BREAKERS 28, 29 AND 33

See Figure 3.1-9. Specifications for these circuit breakers follow:

- Type of Element: Thermal-magnetic
- Type of Trip Ckt: Series
- No. of Poles: 3
- Trip Element Ratings
 - AC Rating: 250 volts
 - 25 amps
- Operating Frequency: 60 cycles
- Interrupting Contact Ratings
 - AC Interrupting Capacity: 240 volts
 - 5000 amps
 - DC Interrupting Capacity: 250 volts
 - 5000 amps

Adjustment. To reset the breaker, the handle must be pushed all the way down, then lifted all the way up (Figure 3.1-9).

Removal. Turn power off at the wall switch before removing breaker leads.

60 CYCLE INPUT CIRCUIT BREAKER (CB 30)

This circuit breaker is physically similar to CB 28, 29 and 33; the main difference is its current rating, which is 50 amps. Figure reference, adjustment and removal of CB 28, 29 and 33 apply also to this circuit breaker.

400 CYCLE MG OUTPUT CIRCUIT BREAKER (CB 31)

This breaker is similar to the preceding ones, but its current rating is 70 amps. See the preceding circuit breaker sections for adjustment, removal, and so on.

60 CYCLE MG BLOWER CIRCUIT BREAKER (CB 32)

This is a three pole breaker rated at 250 volts AC-DC and 15 amps. It has a two position on-off handle for resetting. See Figure 3.1-10.

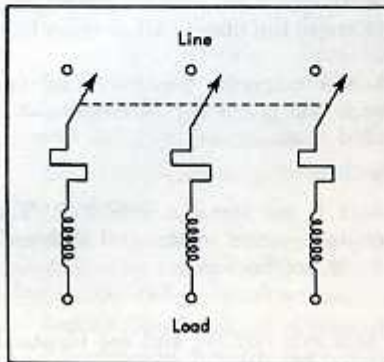
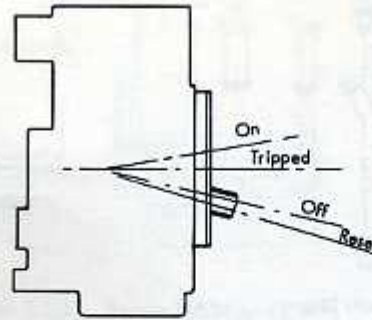
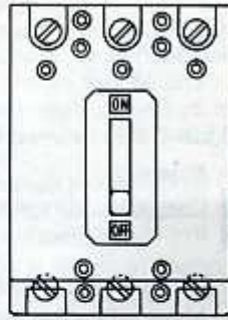
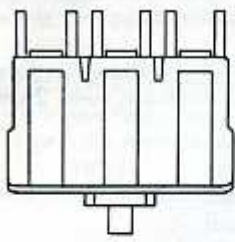

Circuit Diagram

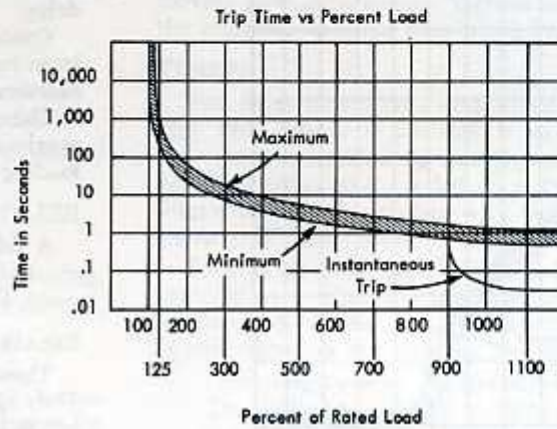

Figure 3.1-9. Circuit Breaker 28, 29, and 33

400 CYCLE POWER SEQUENCING POWERSTAT CIRCUIT BREAKER (CB 34)

This circuit breaker is physically identical to the blower circuit breakers described in Section 3.1.1. The circuit diagram and the curve of trip time vs. percent of rated load are in Figure 3.1-11. Specifications for this breaker are:

- Type of Element: Magnetic
- No. of Poles: 3
- Type of Trip Circuit: Series
- Trip Element Ratings
 - AC Rating: 250 volts
 - 20 amps
- Operating Frequency: 400 cycles
- Auxiliary Contact Ratings
 - Type of Circuit: SPDT
 - AC volts: 125
 - AC amps: 5.0
 - DC volts: 50
 - DC amps: 1.0
- Interrupting Contact Ratings
 - AC Interrupting Capacity: 208 volts
 - 1000 amps

400 CYCLE M/C POWERSTAT CIRCUIT BREAKER (CB 35)

This circuit breaker is physically identical to the blower circuit breakers described in Section 3.1.1. It is of the instantaneous trip type; that is, it *must* trip instantaneously at 130% of rated load.

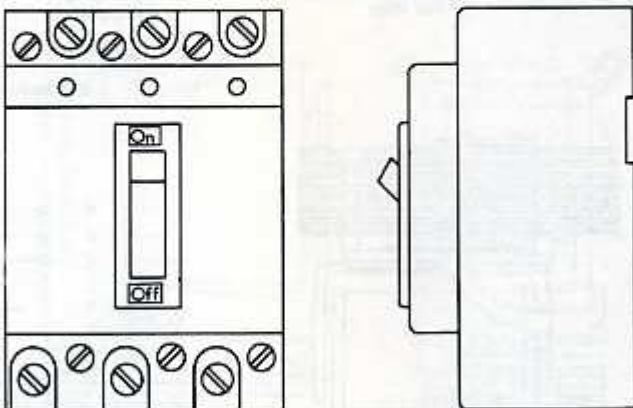
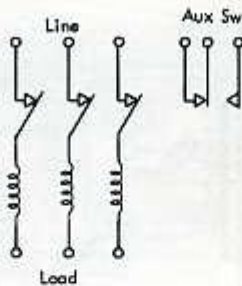

Figure 3.1-10. 60 Cycle Motor-Generator Blower Circuit Breaker



Circuit Diagram

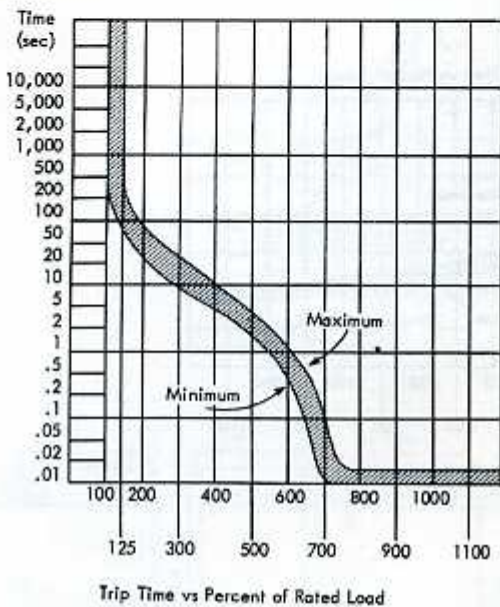

Figure 3.1-11. Characteristics of CB34

Specifications for this breaker follow:

- Type of Element: Magnetic
- Number of Poles: 3
- Type of Trip Circuit: Series
- Trip Element Ratings
 - AC Rating: 208 volts
 - 12 amps
- Operating Frequency: 400 cycles
- Auxiliary Contact Ratings
 - Type of Circuit: SPDT
 - AC volts: 125
 - AC amps: 5.0
 - DC volts: 50
 - DC amps: 1.0
- Interrupting Contact Ratings
 - AC Interrupting Capacity: 208 volts
 - 1000 amps

FUSES

Fuses used in the power control unit are of the cylindrical glass type. Consult Systems reference diagram 9.08.08.0 for a list of fuses, their ratings, and Systems page location.

Fuse 1 is in the sealed box between CB30 and HR29. Fuses 2 to 9 are located on the relay, fuse, and diode panel. See Section 4, "Machine Locations."

The 48 volt supply, (Systems 9.08.03.0) has three fuses in its circuit. Fuse 1 is a 3 amp instantaneous; fuses 2 and 3 are 1 amp delayed blow.

Removal

CAUTION: Always use fuse pullers to remove fuses from live circuits.

3.1.6 Relays, Timers, Contactors, and Starter

Many relays are used in the power control unit but they are of only a few types. For example, relays DR1 through DR28 are IBM P/N 532957.

Two delay timers are in the unit: TD-1 and TD-2. TD-1 is set for 5 seconds delay and TD-2 is set for 3 minutes delay.

Contactors or heavy duty relays are used for interrupting large currents. About 33 are in the unit; most of them have the same part number.

The starter (HR-30) is a magnetic contactor and two overload relays. It protects the motor for all conditions of loading including a stalled rotor.

RELAYS

A relay reference chart is on Systems 9.08.06.0. This chart shows the location in Systems of the coil and each point. For physical locations, see Section 4.

RELAYS DR1 TO DR28

These relays are all IBM P/N 532957 and are identical. They have a contact rating of 4 amps at 120 volts AC. The coil is rated at 120 volts AC. They have six normally open positions and two normally closed positions. See Figure 3.1-12.

Service Checks. Visually check the relays for burned points and contact corrosion.

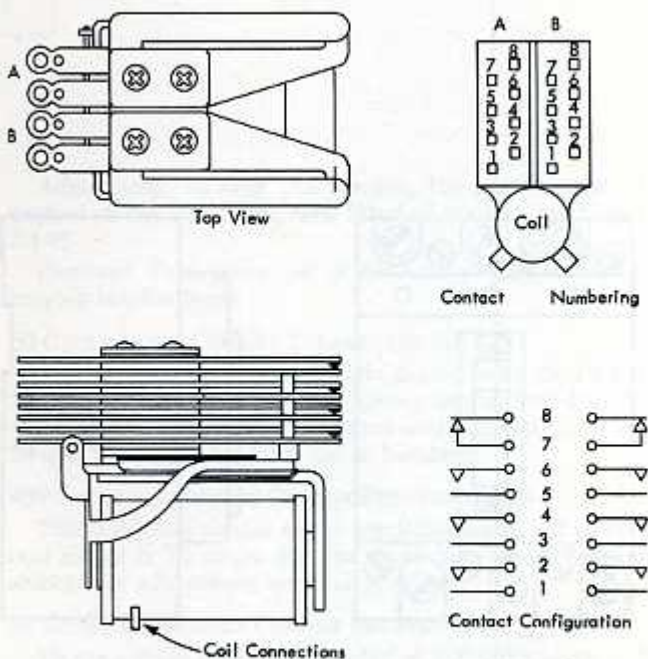

Figure 3.1-12. Relays DR1 to DR28

Adjustments. Burnish the points when necessary. Lubricate the pivot pin occasionally. Form the contact leaves if necessary.

RELAYS DR29 AND DR30

These relays are IBM P/N 111351. They are duo relay type with the following specifications:

- Air gap .021 measured through the core face
- at 40v DC Operate time = 18 ms maximum
- Release time = 7 ms maximum

Contact numbering of these relays is shown in Section 4.

Service Checks. Visually check the relays for burned points, contact corrosion, air gap, and rise.

Adjustments. Same as preceding section.

RELAY DR31

This relay is IBM P/N 532520 (Figure 3.1-13). Specifications are:

- Coil 48 volts DC
- Contact Rating 30 amps at 48 volts DC
- Temperature Rise Max. 55°C over 25°C ambient
- Breakdown 1000 volts RMS at 60 cycles

Service Checks. Visually check the relay for burned points and contact corrosion.

Adjustments. Same as preceding section.

RELAY DR32

DR32 (IBM P/N 70236) is a duo relay type. Its minimum pickup voltage is 85 ± 5 volts AC. One of its contacts has a make-before-break action.

Service Checks. Same as preceding section.

Adjustments. Burnish the points when necessary. Lubricate the pivot pin occasionally. Form the contact leaves for a positive make-before-break action.

RELAYS DR33 AND DR34

These relays (IBM P/N 532521) are of the make-before-break type (Figure 3.1-14). Specifications follow:

- Coil 48 volts DC
- Contact Rating 5 amp at 48 volts DC
- Breakdown 1000 volts RMS at 60 cycles
- Temperature Rise Max. 55°C over 25°C ambient

Service Checks. Same as preceding section.

Adjustments. Same as preceding section.

RELAYS HR36, 37, and 38

These three relays (IBM P/N 72895) are of the heavy duty type with a spring loaded armature. They should pick up at 93 volts.

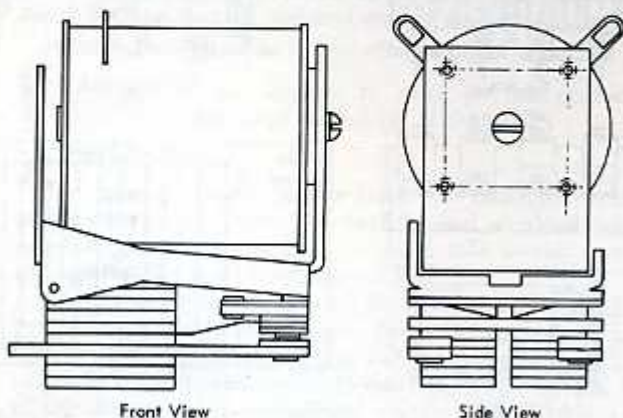

Figure 3.1-13. Relay DR31

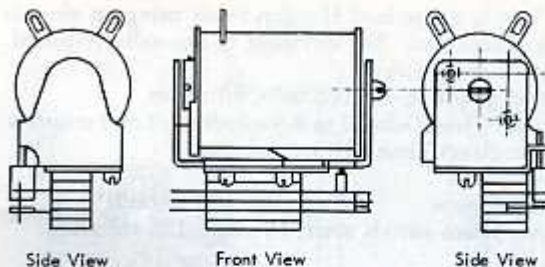

Figure 3.1-14. Relays DR33 and DR34

Service Checks. Same as preceding section.

Adjustments. Burnish points when necessary. Lubricate moving parts occasionally. Tighten and adjust parts so that the armature does not hum when the coil is energized.

TIMERS

Two delay timers are incorporated in the Power Control unit. TD1 (IBM P/N 532989) is set for 5 seconds, while TD2 (IBM P/N 322610) is set for 3 minutes. Systems 9.08.08.0 indicates the locations of these timers on systems diagrams. Refer to Section 4 of this manual for physical locations of these timers.

TD-1. This is a plug-in type of device, using an octal base. Refer to Figure 3.1-15. No servicing will normally be required; if the unit becomes defective, replace it. Specifications on this unit are as follows:

- Operating Voltage 120 volts, 60 cycle
- Timing Range 0 to 10 seconds, set at 5 seconds
- Contact Rating 2 amp resistive at 115 volts AC
- Repeatable Timing Accuracy $\pm 5\%$
- Time delay Starts when coil is de-energized

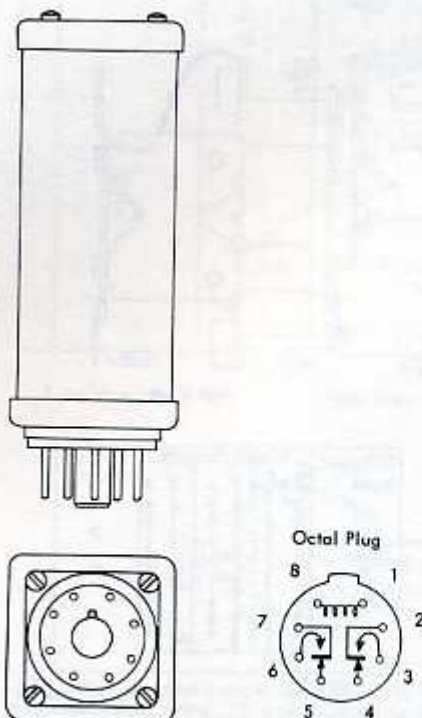

Figure 3.1-15. Time Delay Relay TD1

TD-2. This is a standard Haydon timer using an electric clockwork mechanism. No servicing is normally required. Specifications are as follows:

Operating Voltage 115 volts, 60 cycles
 Range of Time Delay 0 to 4.5 minutes set at 3 minutes
 Approx. Reset Time 15 seconds max.
 Value of Dial
 Graduations .5 minutes (30 seconds)
 Output Micro-switch SPDT, 15 amps, 125 volts AC

CONTACTORS

Contactors are actually heavy duty relays. The name is usually reserved for components having paired sets of contacts which close simultaneously. In the Power Control unit this description applies to components labeled HR1 through HR29. In Systems 2.08.06.0 is a list of these contactors and the systems pages on which their various parts can be found. Section 4 gives the physical locations of these contactors.

CONTACTORS HR1 THROUGH HR28

These components are used to connect power to each of the units in the system. Two contactors (one odd and one even-numbered), are used for each unit in the system, with the exception of the core storage unit, which requires four contactors. Odd-numbered contactors, such as HR1, HR3, and HR5, are all IBM P/N 532935. Even-numbered contactors, such as HR2, HR4, and HR6, are all IBM P/N 532934. Specifications on each of these contactor types are as follows:

Even-Numbered Contactors (P/N 532934) – Figure 3.1-16.

Coil Ratings (AC)

Operating Voltage 115 volts
 Maximum Watts 4.8 watts
 Operating Frequency 60 cycles

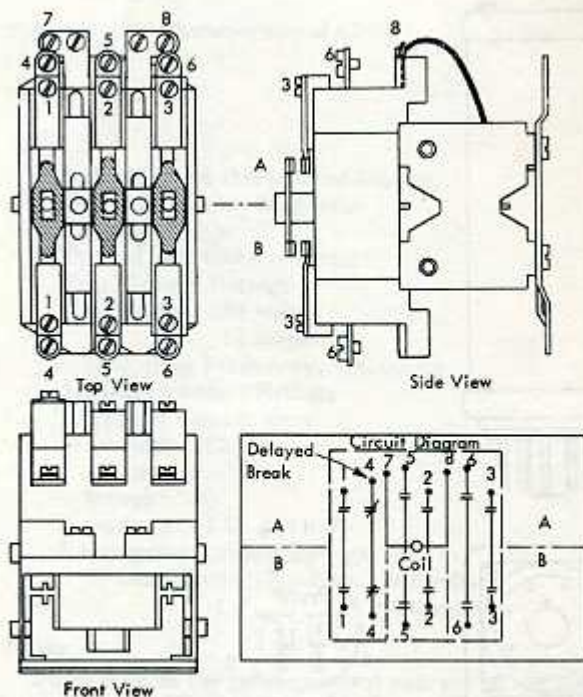

Figure 3.1-16. Even-Numbered Contactors

Main Poles–Contact Ratings

Number of Poles 5 N/O, 1 N/C
 Max. AC Ratings 230 volts, 10 amp
 Max. DC Ratings 250 volts, 10 amp

Interrupting Contact Ratings

AC Interrupting Capacity
 240 volts, 60 amp
 440 volts, 30 amp
 DC Interrupting Capacity
 290 volts, .5 amp
 210 volts, 2 amp
 165 volts, 4 amp
 145 volts, 6 amp
 130 volts, 8 amp
 120 volts, 10 amp

Odd-Numbered Contactors (P/N 532935) – Figure 3.1-17.

Coil Ratings (AC)

Operating Voltage 115 volts
 Maximum Watts 4.8
 Operating Frequency 60 cycles

Main Poles–Contact Ratings

Number of Poles 6 N/O, 2 N/C
 Max. AC Ratings 600 volts, 10 amp
 Max. DC Ratings 250 volts, 10 amp

Interrupting Contact Ratings

AC Interrupting Capacity
 240 volts, 60 amp
 440 volts, 30 amp

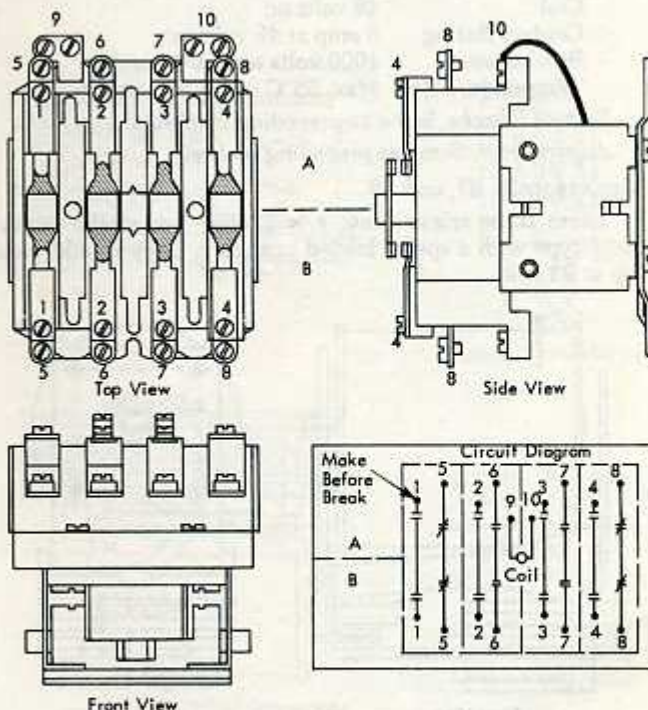

Figure 3.1-17. Odd-Numbered Contactors

DC Interrupting Capacity

290 volts, .5 amp
210 volts, 2 amp
165 volts, 4 amp
145 volts, 6 amp
130 volts, 8 amp
120 volts, 10 amp

Service Checks. Visually check the contactors for burned points or contact corrosion. Be sure that screw terminals are tight. Check for free plunger movement.

Adjustments. Burnish the points when necessary. Do not lubricate the plunger. If power will not sequence up properly, tap the plunger with a well insulated tool. This will insure a good connection between the moving and stationary points.

POWER-ON SEQUENCING CONTACTOR (HR29)

This contactor (IBM P/N 532522) is one of the first energized when power is brought up (see Figure 3.1-18). Specifications for HR29 are:

Coil Ratings (AC)

Operating Voltage	110 volts
Maximum Watts	10
Operating Frequency	60 cycles

Main Poles—Contact Ratings

Number of Poles	3 N/O
Max. AC Ratings	600 volts, 75 amp
Max. DC Ratings	45 volts, 75 amp

Interrupting Contact Ratings

AC Interrupting Capacity	240 volts, 450 amp
	440 volts, 225 amp

DC Interrupting Capacity

200 volts, 2.5 amp
110 volts, 10 amp
80 volts, 20 amp
60 volts, 40 amp
52 volts, 60 amp
45 volts, 75 amp

Maximum coil temperature rise 55°C over 40°C ambient.

HiPot 2200 volts RMS, 60 cycles, for one minute between current-carrying and non-current-carrying parts.

Service Checks. Take power off at the wall switch, remove the contact cover and visually inspect the contacts for burns or corrosion. Check the plunger for free movement. Be sure that all terminal screws are tight.

Adjustments. Same as in preceding section.

CAUTION: Do not attempt to work on this contactor unless power has been turned off at the wall.

MAGNETIC STARTER

The magnetic motor starter (IBM P/N 532975) consists of a magnetic contactor and two thermal overload relays functioning as side switches. A third side switch is also mounted in this unit. See Figure 3.1-19.

The magnetic starter is used for full voltage starting of squirrel-cage induction motors. It provides overload and undervoltage protection. Undervoltage protection against untimely restarts after power failure is obtained by the use of the starter and a momentary contact reset pushbutton. This method is necessary because HR29 will drop the magnetic starter.

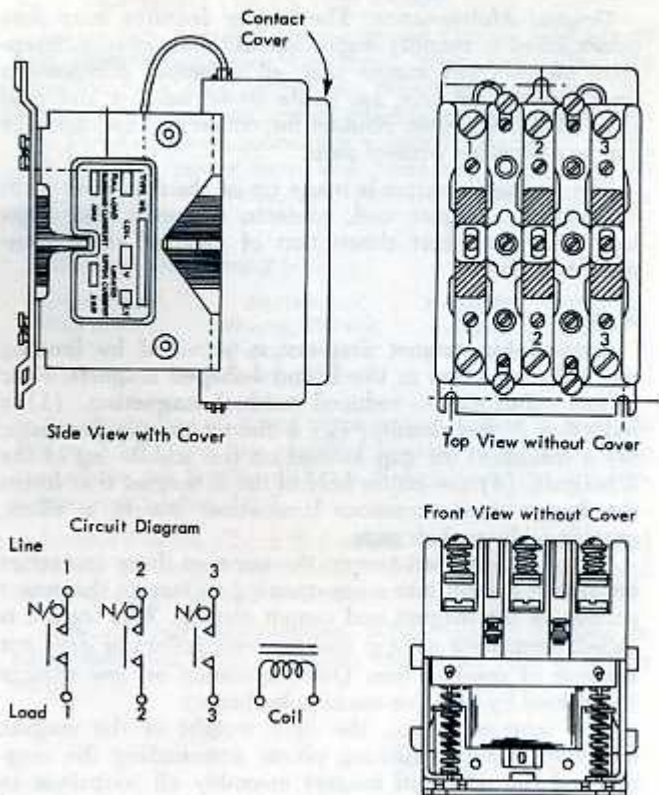
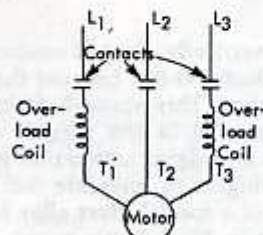
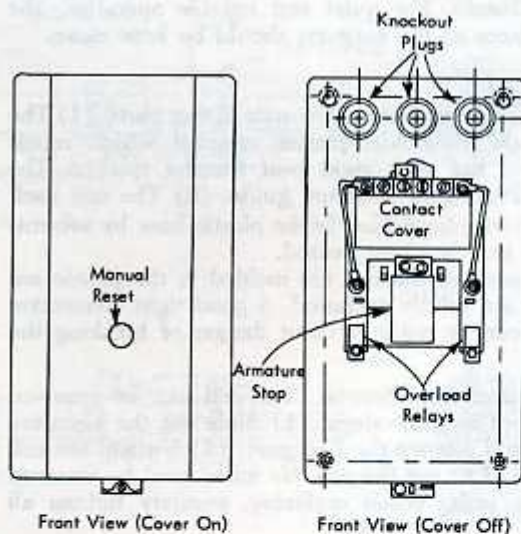

Figure 3.1-18. Power-On Sequencing Contactor (HR29)



NEMA size 4 magnetic starter 208/220v, 60 cycle, 3 ϕ , 3 pole. Overload heater rating, 121 amps. Coil rating 208/220v, 60 cycle.

Figure 3.1-19. Magnetic Starter

General Maintenance. The starter features snap-slide construction to simplify inspection and maintenance. Snap-slide construction means that all principal components (movable contact arm, arc chute cover, magnet and coil) snap or slide together. Routine inspection and maintenance can be performed without tools.

The magnetic starter is made up of the following main components: magnet, coil, contacts, terminals, and overload relays. A short description of each of these components follows.

MAGNET

Dependable magnet drop-out is provided by limiting residual magnetism in the E and I-shaped magnets. Four factors contribute to reduced residual magnetism: (1) a reduction in flux density; (2) a shorter unique flux path; (3) a machined air gap located on the middle leg of the E magnet; (4) the center hole in the E magnet that forces the flux to cross numerous laminations which, in effect, provide additional air gaps.

The air gap will remain the same on these contactors because it is built into a non-wearing surface in the center portion of the magnet and cannot change. This feature is called permanent air gap and prevents failure to drop out because of residual flux. Quiet operation on low voltage is obtained by effective use of pole shaders.

The magnet design, the light weight of the magnet assembly, sound-deadening plastic surrounding the magnet and the non-rigid magnet assembly all contribute to quiet pickup and quiet operation. The magnet is not bolted down, and the armature spring clip permits even seating of the large striking surfaces of the self-aligning magnet.

Service Checks. For quiet and reliable operation, the mating surfaces of the magnets should be kept clean.

COIL

The strongbox magnet coil consists of two parts: (1) The case is made of molded-plastic material which repels moisture and has very good heat transfer quality. The case also serves as an armature guide. (2) The coil itself is of special wire imbedded in the plastic base by solventless varnish. It is then heat treated.

The terminals of the coil are molded in the plastic enclosure and are solidly anchored. A good tight connection to the coil can be made without danger of breaking the terminals.

Removal and Replacement. The coil can be removed from the front in three steps. (1) Slide out the armature spring clip and remove the I magnet. (2) Unsnap the coil retainers. (3) Lift out the coil. No wires need be removed to exchange coils. When replacing, securely tighten all screws.

CONTACTS

The starters have vertically slanted contacts that resist the accumulation of dust and dirt because the contact surfaces run up and down. This vertical design, combined with the horizontal motion of the magnet and movable contact arm, provides a wedging action that gives positive-make, positive-wipe, higher-tip pressure and less bounce.

Contacts are made of a special silver alloy for long weld-free life. No dressing or filing is necessary. Contacts are further protected by the arc chute design that "blows out" arc, and by cooling action of the grid.

Service Checks. To inspect contacts, loosen two screws

and remove the contact cover. Compare a used contact with a new one to determine how much tip life remains. The silver alloy contacts need be replaced only when nearly all of the tip material is gone.

NOTE: Do not file the contacts. Filing or otherwise dressing the contacts simply reduces contact life by wasting the silver alloy.

Adjustments. When contacts are replaced, they may be adjusted as follows:

1. Secure molded contact support to back plate with mounting screws partially tightened.
2. Place $\frac{3}{32}$ inch spacers in magnet gap at front and rear of magnet and close contactor manually.
3. Shift stationary contact support until extreme right and left contacts just meet.
4. Tighten mounting screws securely.

Removal and Replacement. To replace a movable contact, twist downward and lift it out of the guides. Insert the new contact by depressing the new spring and twisting to a horizontal position between the guides. Be sure the spring retainer is in place.

To replace stationary contacts, remove screws and movable contact assembly. Remove a single screw for each stationary contact and replace with a new contact. Back and front stationary contacts are identical.

NOTE: The stationary contact support should not be removed, except for replacement when damaged.

TERMINALS

The terminals on the starters are located at the front of the device. All internal wiring is made to separate screws.

OVERLOAD RELAYS

Bi-metallic thermal-overload relays are provided. The relays are furnished hand reset, but may be readily changed to automatic reset by the flip of a lever. As the motor current increases beyond normal, the increased temperature of the heater causes the relay to trip and, as a result, the motor is disconnected from the line before it becomes overheated.

Refer to Figure 3.1-19 for a circuit diagram of the starter.

3.1.7 Resistors and Rectifiers

Resistors R1 to R4 are listed in Systems 9.08.08.0, as are rectifiers RT1 to RT7. In addition to these, others are located elsewhere in the unit. For instance, in the 48 volt power supply is a large silicon rectifier and a 45 watt resistor. Besides this, a number of resistors and rectifiers can be found in the excitation-regulation panel.

RESISTORS R1, R2, R3, and R4.

These resistors are in series with diode rectifiers as current limiting devices. They are physically located on the relay, fuse and diode panel. (See Section 4.)

Service Checks. If the resistors appear discolored, turn off power and tap at them with a suitable implement. Badly burned resistors will come apart easily. Disconnect suspected resistors and check them with an ohmmeter.

RECTIFIERS

Rectifiers RT1 to RT7 are of the 1N93 type. The rectifier used in the 48 volt power supply is shown in Figure 3.1-20. Its output is rated at 40 volts and 4.7 amperes.

Service Checks. Check crystal diodes for forward and back resistance. Visually inspect the 48 volt rectifier for burned spots and bent plates.

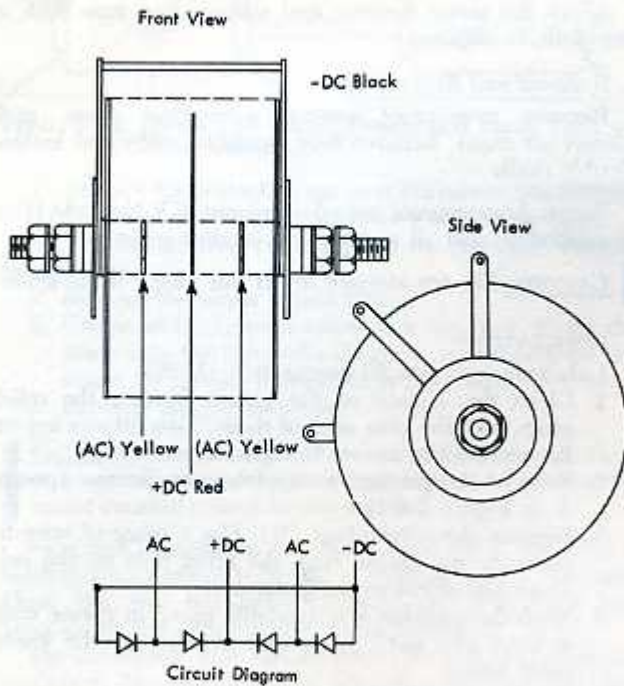

Figure 3.1-20. 48 Volt Supply Rectifier

3.1.8 Connectors and Exterior Cables

Connectors mounted on the Power Control unit are of two main categories: Winchester type and cylindrical screw-on type. One 34-position Winchester connector accepts a cable carrying control information between PC and MG. Three screw-on connectors accept cables which carry: (a) 60 cycle power from wall receptacle to PC, (b) 60 cycle power from PC to MG, (c) 400 cycle power from MG to PC.

Refer to the following table:

CONNECTION	RATING	POSITIONS	IBM P/N
Wall to PC	150 amp, 250 volt	4 + gnd	532939
PC to MG	150 amp, 250 volt	4 + gnd	532937
MG to PC	100 amp, 250 volt	4 + gnd	532936

An illustration of these three power cables is given in Figure 3.1-21. For the physical location of each of these connectors, see Section 4. For a discussion of the MG connectors, see Section 3.2.5.

Service Checks. Check that cables are securely tightened and that all contact surfaces are clean. Inspect for frayed cables and tight ground connection.

Removal and Replacement. When replacing leads to cable terminals, strip insulation $\frac{1}{16}$ of an inch from the ends.

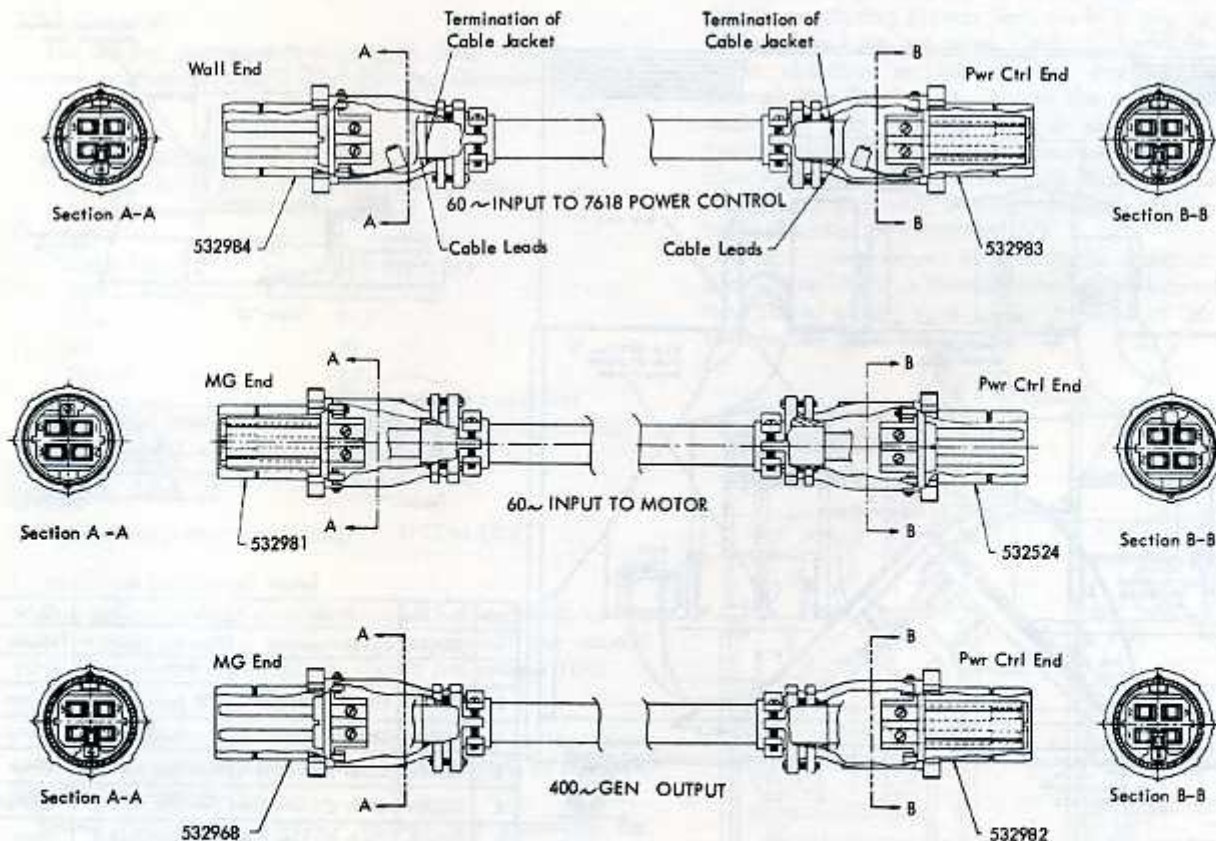

Figure 3.1-21. 7618 Power Control and Motor-Generator Exterior Power Cables

3.2 Power Converter

Refer to Figure 3.2-1 for an illustration of the inside of the IBM 7608 Power Converter.

3.2.1 Motor

The drive motor for the power converter is mounted on a metal platform common to the motor and generator, and a flexible coupling mechanically links both armature shafts. Motor characteristics follow:

Volts	220/240
Frequency	50/60 cycles
Phase	3
Horsepower	50
RPM	3425
Running Current	133 amp (approx.) at full load
Slip	2%
Type	Delta wound induction motor

INSPECTION

Inspect the motor for hot spots, after running for several hours under load. Inspect for excessive vibration, misalignment with generator shaft, loose flexible coupling, loose motor mounts, burned or frayed cables, loose wire terminals, loose motor end bells, excessive grease, excessive noise or vibration caused by faulty bearings, and charred field wire insulation caused by overheating.

CAUTION: Remove all power before cleaning.

Cleaning

Clean the motor exterior and surrounding area with a dry cloth, as required.

Removal and Replacement

Remove soundproof covers, connecting wires, and blower air ducts. Remove four mounting bolts and loosen flexible shaft.

NOTE: A waterproof gray dag cement (GE No. D6A1F3) is applied to seal all motor joints against moisture.

CAUTION: Do not attempt to lift this motor while alone.

LUBRICATION

Lubricate with IBM 20 grease, P/N 117397.

1. Clean the surface of the grease fittings, the relief plugs, and the area around them. Two fittings are on the motor; two are on the generator.
2. Remove the protective cap from the fittings (points A on Figure 3.2-2).
3. Remove the relief plugs (B). Use a piece of wire to ream the old grease from the relief hole on the collector end-shield of the generator.
4. With the machine at a standstill, pump in grease with a hand gun until the grease appears at the lower relief hole.
5. Run the machine for ten to thirty minutes.
6. Clean and replace the relief plugs.

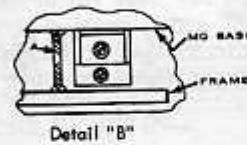
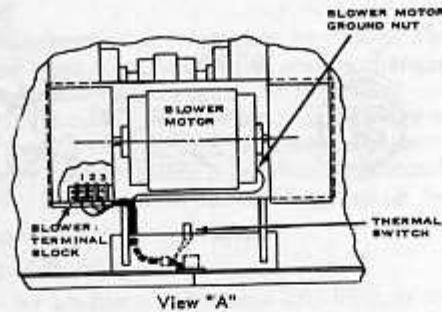
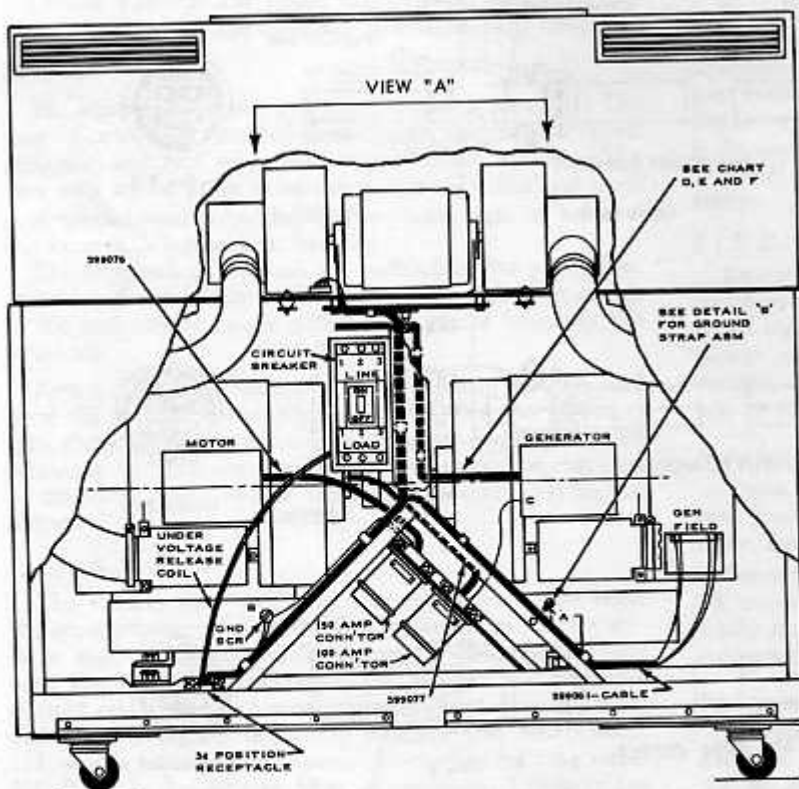

Motor Leads	Phase
1,6,7	Ø1
2,4,8	Ø2
3,5,9	Ø3

Jumper Chart

Code	Part No	From	To	Color
A	599078	Frame Member	Gen and Motor Base	Green
B	599079	Gen and Mtr Base	150 Amp Conn	Green
C	532802	100 Amp Conn	Gen Box Lead-4	White
D	532884	Cir Br Ø1 Line Side	Gen Box Lead-1	Gray
E	532885	Cir Br Ø2 Line Side	Gen Box Lead-2	Orange
F	532886	Cir Br Ø3 Line Side	Gen Box Lead-3	Lime

Figure 3.2-1. 7608 Power Converter

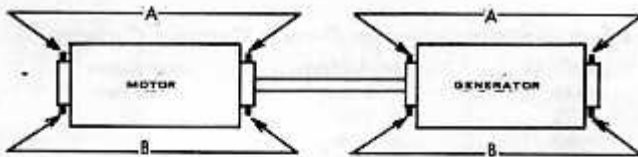

Figure 3.2-2. Location of Grease Fittings and Relief Plugs on Motor-Generator

7. Replace the protective cap over the lubrication fittings. (Some machines may not have a protective cap.)

As a quick method for checking the need for bearing lubrication:

1. Remove the upper grease fitting.
2. Use an ordinary soda straw as a dip stick. Force the straw into the reservoir; if grease is observed on the straw, no further lubrication is necessary.
3. Replace the grease fitting.

CAUTION: Use IBM 20 synthesized grease or equivalent. A lower temperature grease may melt and flow into the motor causing a short circuit and fire.

Frequent lubrication or lubrication while the unit is moving may destroy both the bearing and the grease seal. Once the seal has been fractured, lubricant will leak through to the winding and cause premature failure.

Do not check and re-lubricate the MC set during installation. The manufacturer lubricates the bearings with a metered charge of grease that should last for 52 weeks (3-shift operation). Because the metered charge of grease may not fill the cavity, there may be no grease on the relief plug.

3.2.2 Generator

The 30 kw generator is a 14 pole, four wire WYE-connected AC generator with the following characteristics:

INPUT

Field Requirements

95 volts DC at 10.7 amp for 37.5 kVA output

OUTPUT

Volts (rms)	208 (approx)
Volts (peak)	295 \pm 5%
kVA	37.5
kw	30
Power Factor	0.8
Frequency	412 to 420 cps nominal (389 to 441 max deviations)
Amplitude Modulation	0.5%

OTHER

Ambient temperature range 0°C to 40°C

GENERATOR LOADING

The generator load should require 25% to 100% of the rated output. Normal load variations should not exceed 20%. Transient load variations should not exceed 10%.

SERVICE CHECKS

Measure the output characteristics under various load conditions. Adjust the exciter-regulator controls to produce the required output.

Visual Inspection. Visually inspect the generator for loose mounting screws, loose end bells, broken brushes, arcing brushes, loose brush pigtailed, excessive vibration and noise, overheating loose terminal connections, frayed or broken cables.

Cleaning. Remove the rear end bell and clean the slip rings and brush holders with a clean, dry cloth. Clean the surrounding area as required. Avoid damaging brush springs and pigtailed.

Lubrication. For lubrication of the generator, see Section 3.2.1, Motor Lubrication.

ADJUSTMENT

Adjust the generator mounting position for best alignment with the motor and flexible coupling.

REMOVAL AND REPLACEMENT

Remove the air ducts, mounting bolts and flexible coupling. Slide generator out.

CAUTION: Do not attempt to lift alone.

Brush Inspection. Check the brushes (IBM P/N 599083) every three months, and replace them if they are less than one inch long. Check the brush spring tension at the same time by lifting each spring with a finger and seeing that the springs have about the same tension. If any spring feels weaker than the rest, check that the spring is anchored in the proper place and is not broken.

Brush Replacement. Remove the generator end bell, loosen brush pigtail connections, and insert new brushes. Place a piece of crocus cloth under the brush and rotate the armature through a small arc until the brush is worn to fit the slip ring curvature. Remove the carbon filings and reassemble.

3.2.3 Ventilating System

The motor-generator used in the 7090 requires a power-driven ventilating system because it is placed in a sealed enclosure to keep out noise. Cool air, drawn in through the baffle chamber on top of the motor-generator, flows through the lined ducts, enters the motor and generator enclosures and passes over their surfaces. It is then exhausted through the hoses connected to the motor driven blower. Blowers force the hot air through their own lined ducts until it is sent out the chimney at the rear of the baffle chamber. See Figure 3.2-3.

If the temperature in the motor generator enclosure rises above 135°F, a thermal interlock switch will open and turn power off the system. The location of this switch can be seen in Figure 3.2-1.

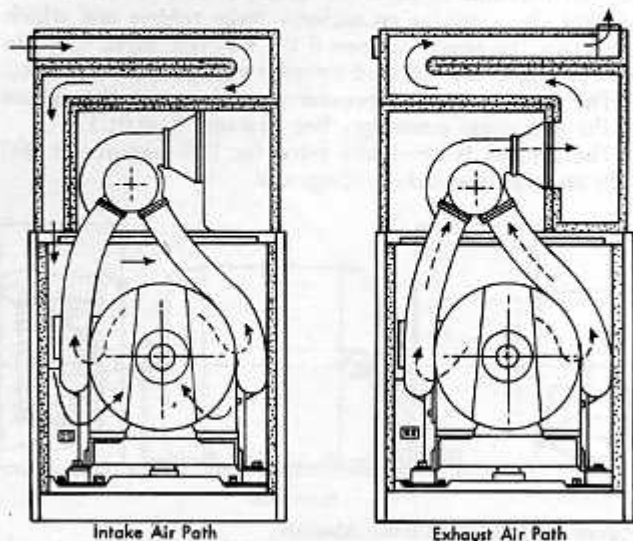

Figure 3.2-3. Air Flow Through the 7608 Power Converter

MOTOR

The motor used in the 7608 ventilating system is described as follows:

Horsepower	1	Phase	3
Voltage	208	RPM	3450
Cycles	60	Bearings	Ball

Service Checks. Check for noisy bearings, overheating, loose mounting bolts, loose blower coupling, and loose electrical connections.

Removal. To remove the motor, first remove the complete motor-blower assembly by loosening the hose clamps and unbolting the base at the shock mount connections. The motor may now be removed from the base by first opening the scrolls and loosening the set screws in each motor-blower coupling, then taking out the four base screws and lifting out the motor. See Figure 3.2-4.

BLOWER

A two-scroll, squirrel-cage type of blower is used in the ventilating system.

Service Checks. Check for excess noise and vibration. Check for a tight setscrew.

Removal. Take out the complete motor-blower assembly as explained in the motor removal section. Open the scroll and loosen the setscrew in the motor blower coupling and also the screw located on the inside bottom of the scroll. Then unscrew the scroll mounting bracket and lift off the scroll and squirrel cage assembly. See Figure 3.2-4.

3.2.4 Reset Switch

The reset switch used in the Power Converter is a circuit breaker consisting of a thermal and an independent magnetic trip unit, together with an operating mechanism with contacts all enclosed in a black molded phenolic case. The operating mechanism is of the quick-make, quick-break type. The breaker has a single operating handle and utilizes a common trip which enables the breaker to open on an overload on any pole.

In addition to a thermal bimetal trip which provides the necessary time delay feature desired for overload protection, an independent instantaneous magnetic trip is provided in this breaker for short-circuit protection. The breaker also contains an under voltage release coil which will allow the points to open if the 60 cycle input drops to between 30% and 60% of its rated voltage (120 volts AC).

The three points this breaker controls are on the output of the 400 cycle generator. See Systems 9.09.01.1.

The breaker is nominally rated for 100 amperes at 600 volts on 60 cycles. Other ratings are:

Effect of Temperature on Current Carrying Capacity

AMBIENT TEMP °C	AMP RATING 60 CPS	AMP RATING 400 CPS
25	100	82
40	86	70
50	76	63
60	63	53

AC Interrupting Capacity

VOLTAGE	CURRENT
600v	15,000 amp
240v	20,000 amp

Refer to Figure 3.2-5 for an illustration of the circuit breaker and related information.

SERVICE CHECKS

The MG circuit breaker may open for any of the following reasons:

1. Continued overload
2. Short circuit
3. Low motor input voltage

ADJUSTMENT

To reset the breaker, the handle must be pushed all the way down, then lifted all the way up. See Figure 3.2-5.

REMOVAL

To remove the breaker, first shut power off, then disconnect the power leads from the base of the MG. Now the connections to the breaker terminals may be disconnected and the breaker unbolted from the frame.

3.2.5 Connectors

Three connectors are located in the power converter unit.

CONNECTION	RATING	POSITIONS	IBM P/N
To Motor	150 amp, 250 volt	4 + gnd	599006
From Gen.	100 amp, 250 volt	4 + gnd	599005
To Blower and Under-Voltage Coil	250 volt	34	532480

All connectors are intended for "disconnect use" only; they are not intended for breaking current. Figure 3.2-6 shows the 150 and 100 amp connectors. The other connector is a Winchester type.

SERVICE CHECKS

Check for clean, tight fittings. Inspect for frayed cables. Check for tight ground connection.

REMOVAL AND REPLACEMENT

When replacing leads to wire terminals, strip insulation $\frac{1}{16}$ of an inch from the ends.

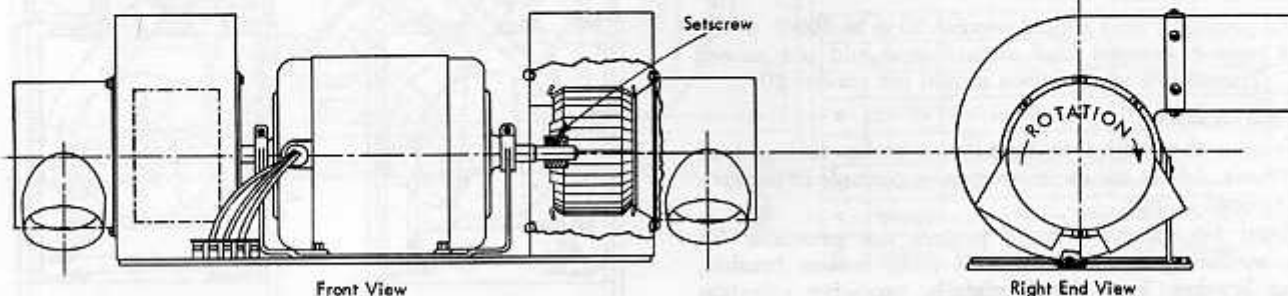

Figure 3.2-4. Motor-Blower Assembly

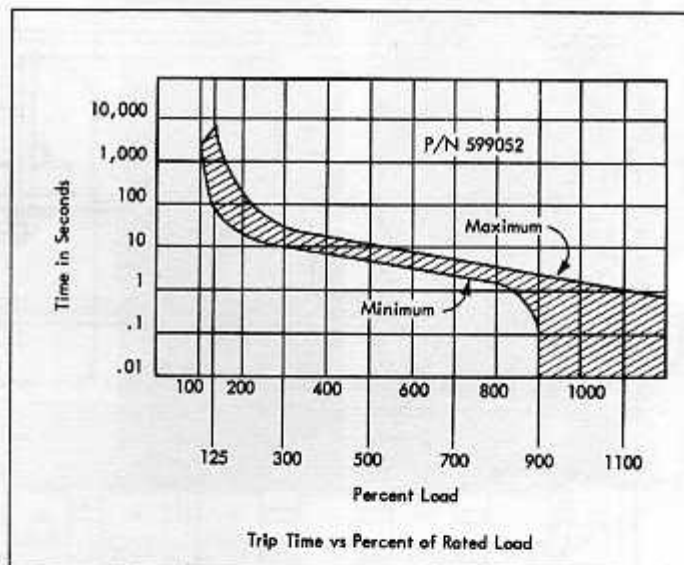
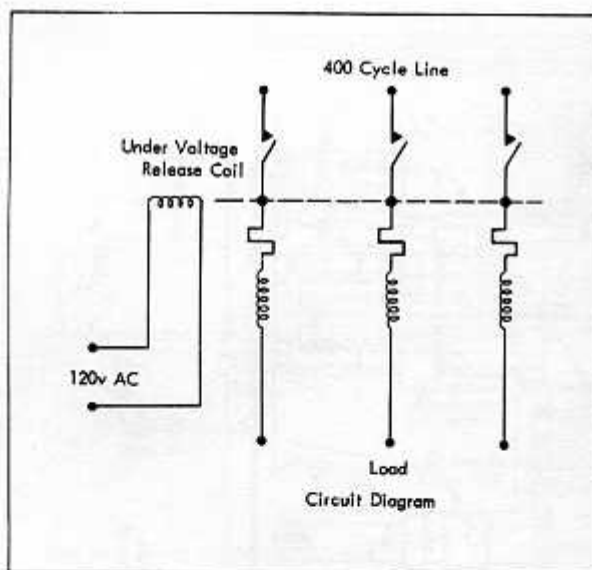
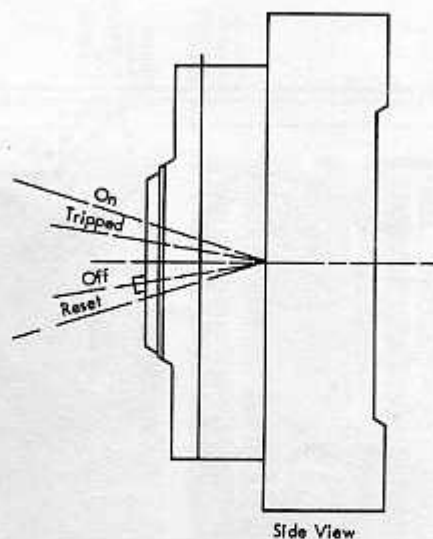
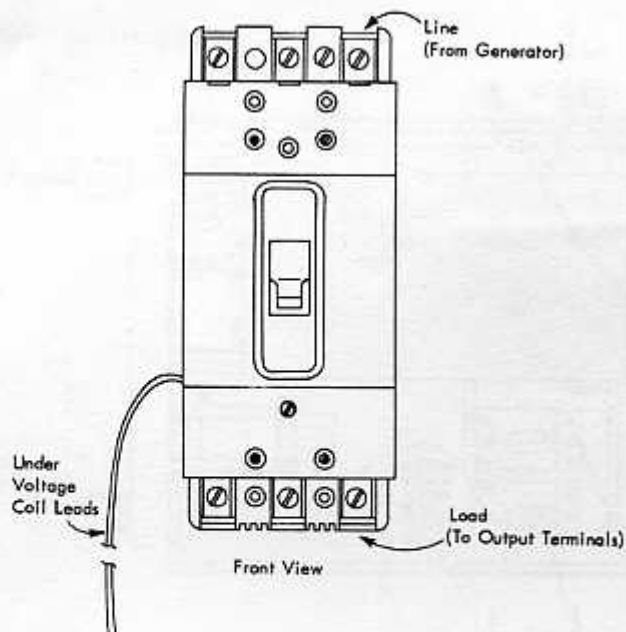

Figure 3.2-5. Motor-Generator Circuit Breaker-Reset Switch

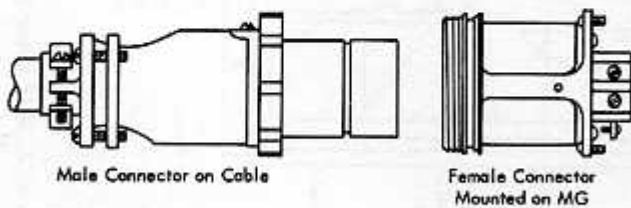

Figure 3.2-6. 100 and 150 Amp Connector

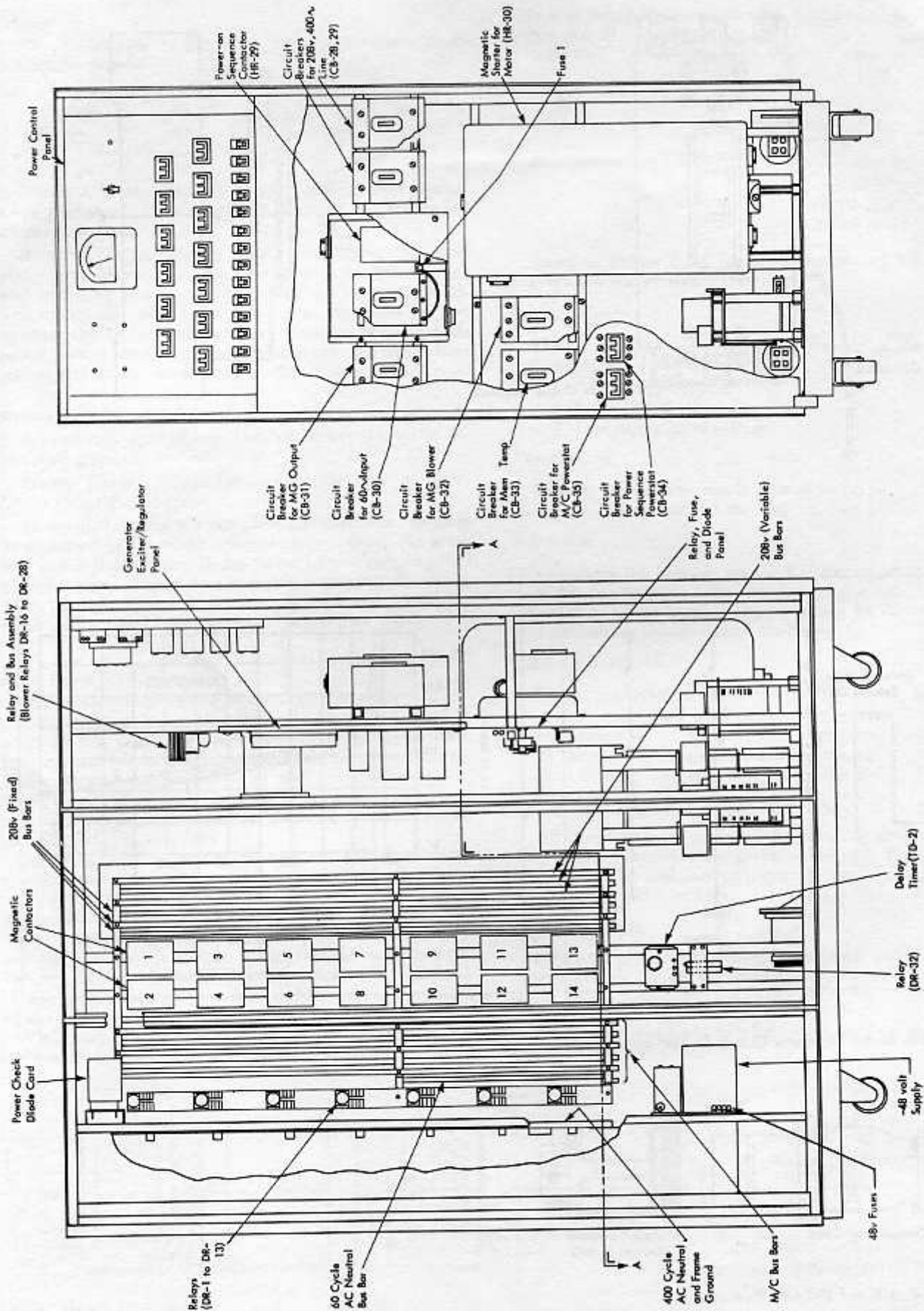

Figure 4.1-1. 7618 Power Control

4 Machine Locations

4.1 Power Control

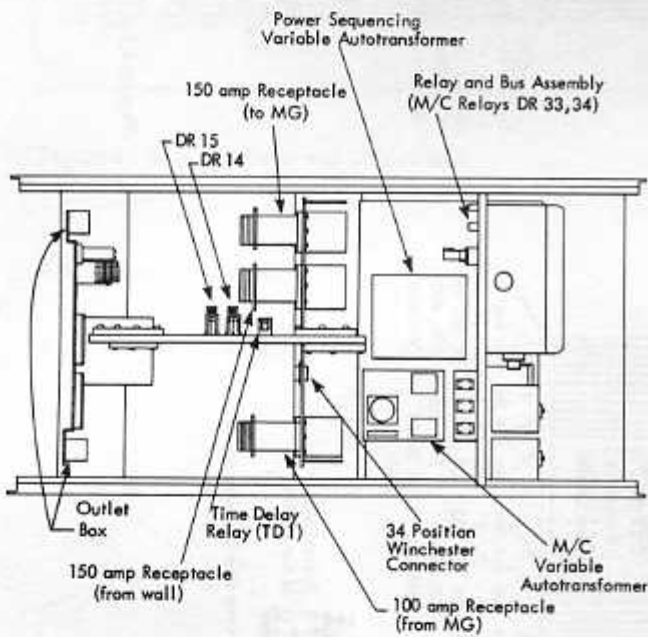

Figure 4.1-1A. Cross-Section A-A

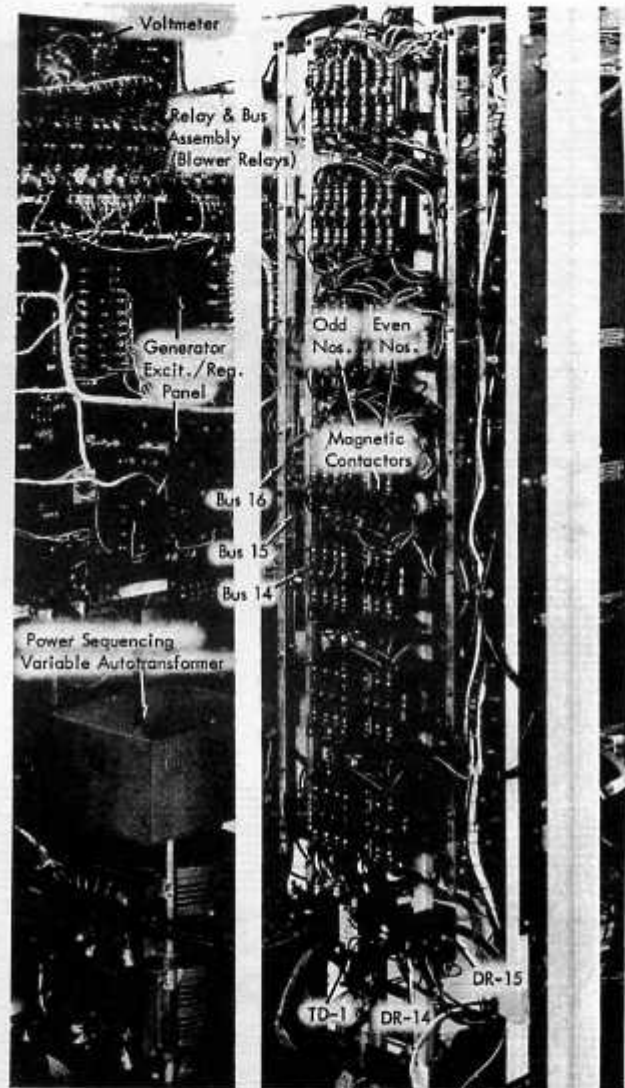

Figure 4.1-2. Left Rear of 7618 Power Control

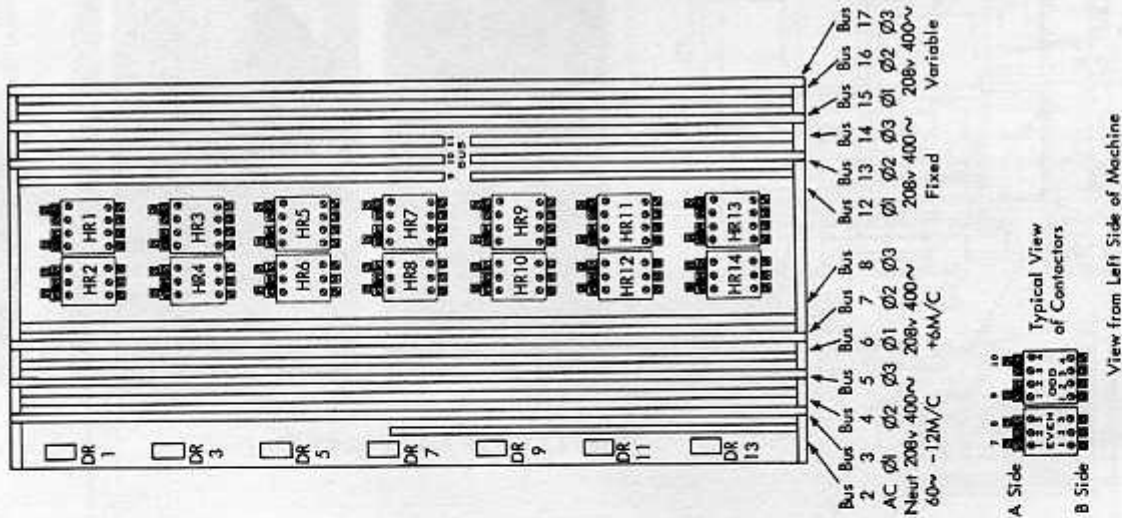
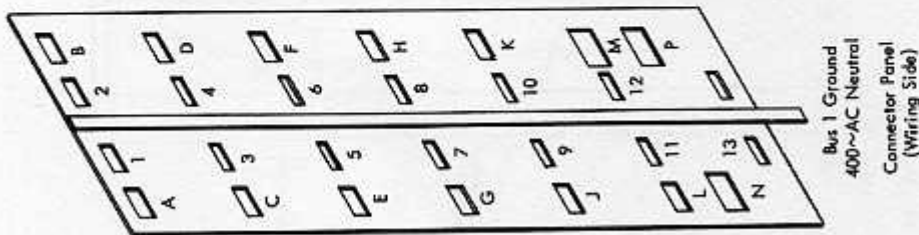

Figure 4.1-3. Left Side of 7618 Power Control

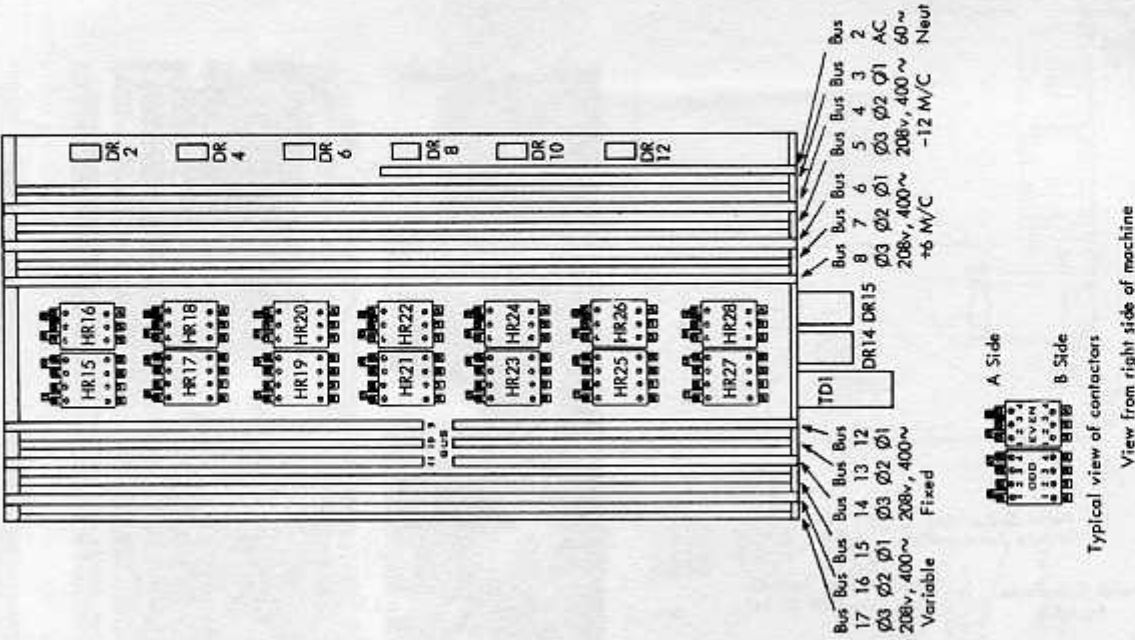

Figure 4.1-4. Right Side of 7618 Power Control

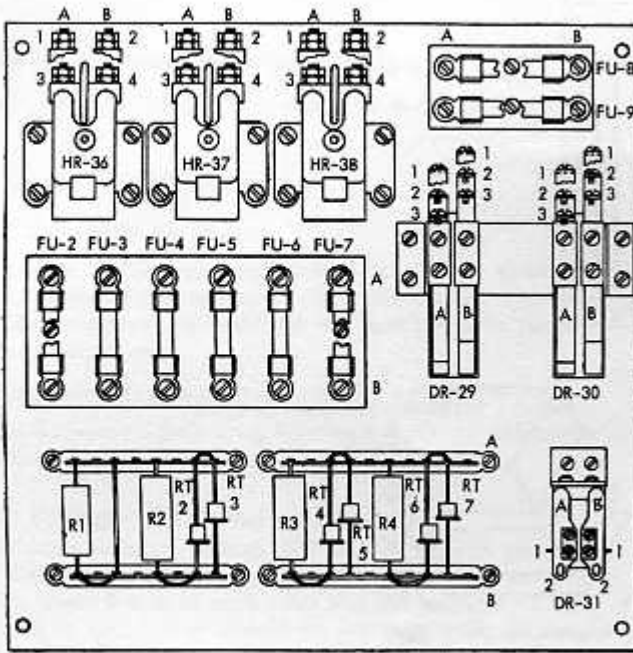

Figure 4.1-5. Relay, Fuse, and Diode Panel

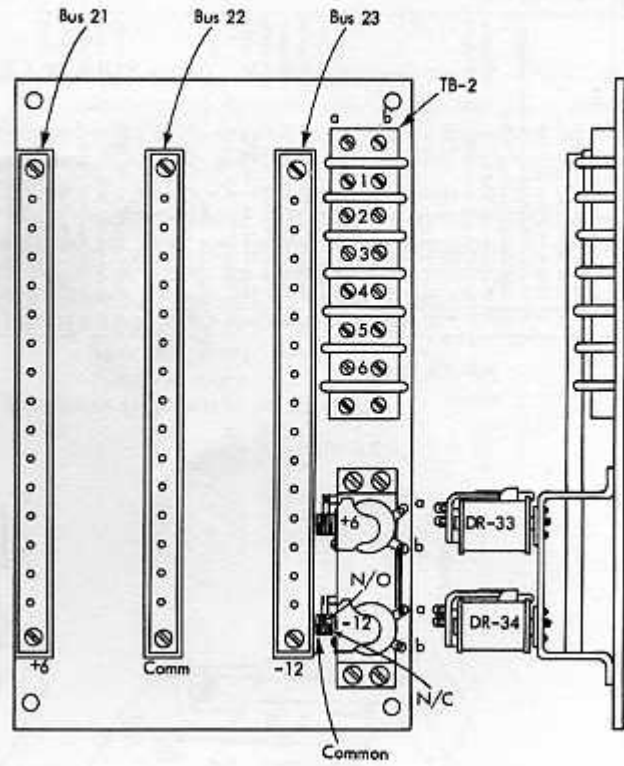

Figure 4.1-6. M/C Relay and Bus Assembly

4.2 Power Converter

See Figure 3.2-1 for power converter physical locations.



International Business Machines Corporation
Data Processing Division
112 East Post Road, White Plains, New York